



ULTIMHEAT

HEAT & CONTROLS



CONNECTION BLOCKS IN CERAMIC & PA66





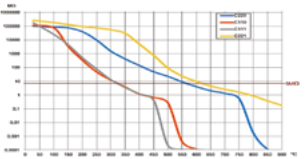

- Thermally responsive devices for fire detection: See catalogue No.9
- Enclosures & accessories for immersion heaters & temperature sensors: See catalogue No.11

Contact us



Because of permanent improvement of our products, drawings, descriptions, features used on these data sheets are for guidance only and can be modified without prior advice

| | | | |
|-----------|---|--|--------|
| Section 1 | Summary | | P1-2 |
| Section 2 |  | History of ceramic connection blocks | P3-10 |
| |  | Technical introduction to ceramic and PA66 connection blocks | P11-20 |
| Section 3 | List of references | | P1 |



| Ceramic connection blocks | | | | P1-30 |
|---------------------------|---|----|--|--------|
| Section 4 |  | BA | 250V steatite connection blocks, protected against electrical shocks, for temperature up to 230°C, brass terminals, 4mm ² | P3-4 |
| |  | BU | 450V steatite connection blocks, protected against electrical shocks, for temperature up to 230°C, brass terminals, 4 to 10mm ² | P5-7 |
| |  | BU | 450V steatite connection blocks, protected against electrical shocks, for temperature up to 230°C, brass terminals, 16 to 25mm ² . Can be mounted on 16x3mm bar | P8 |
| |  | BL | 450V steatite connection blocks, protected against electrical shocks, for temperature up to 230°C rectangular brass terminals, 16, 25 and 35mm ² , with direct pressure screws or indirect pressure plate. In 35mm ² , they can be mounted on 35mm "top hat" rail (EN50022) | P9-12 |
| |  | BJ | 450V steatite connection blocks, protected against electrical shocks, for temperature up to 650°C stamped terminals in brass, steel, nickel or Aisi 304, with 2 entries rectangular hole 2x6mm ² , with direct pressure screws or indirect pressure plate. Can be used as a very high temperature junction box | P13-14 |
| |  | BK | 750V steatite connection blocks, not protected against electrical shocks, for temperature up to 650°C, nickel terminals with pressure plate, 6 to 10mm ² | P15-16 |



| | | | | |
|-----------|---|------------|---|--------|
| Section 4 |  | BK | 750V steatite connection blocks, not protected against electrical shocks, for temperature up to 650°C, nickel terminals with pressure plate, 16 to 25mm ² . Can be mounted on 16x3mm bar | P17 |
| |  | BK | 750V steatite connection blocks, not protected against electrical shocks, for temperature up to 650°C, nickel terminals with pressure plate, 35 to 50 mm ² . can be mounted on 35mm "top hat" rail (EN50022). | P18 |
| |  | BCA BCB | 750V steatite connection blocs, not protected against electrical shocks, for temperature up to 650°C, stainless steel terminals, 2.5mm ² to 10mm ² | P19-23 |
| |  | BCC | 750V steatite connection blocks, for temperature up to 650°C, protected stainless steel terminals, for fire resistant cables, 1.5mm ² to 4mm ² . | P24 |
| |  | BY | 230°C steatite round connection blocks | P25-26 |
| |  | BM | Ceramic connection blocks for electrical motors and heaters. | P27-28 |
| |  | BZ | 500°C Ceramic grommets | P29 |
| |  | BH | C610 Alumina ceramic insulators for sheathed heaters | P30 |

PA66 connection blocks

P1-9

| | | | | |
|-----------|---|-----|---|------|
| Section 5 |  | BF | Flat PA66 connection blocks, T200°C | P3-5 |
| |  | BG | Elevated PA66 connection blocks, T200°C | P6-7 |
| |  | 66A | Quick connect terminals, saddles, jumpers for connection blocks | P8-9 |



Because of permanent improvement of our products, drawings, descriptions, features used on these data sheets are for guidance only and can be modified without prior advice

History of ceramic connection blocks



Because of permanent improvement of our products, drawings, descriptions, features used on these data sheets are for guidance only and can be modified without prior advice



Historical introduction of ceramics used in connection blocks

Because of permanent improvement of our products, drawings, descriptions, features used on these data sheets are for guidance only and can be modified without prior advice

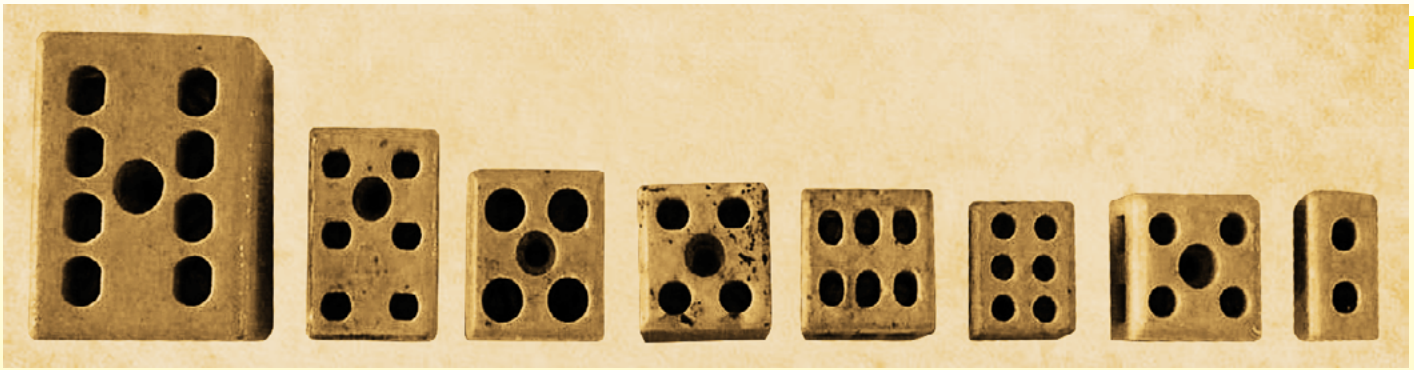

Porcelain connection blocks, 1930-1950's (Ultimheat collection)

Porcelain

Hard Porcelain, originated from China, whose manufacturing process has been closely guarded for centuries, owes its characteristics of whiteness, fineness, resistance to temperature, and hardness to the use of two particular minerals, kaolin, ("Gao Ling Tu 高岭土" in Chinese, which can be translated as "Clay of Gao Ling City", located north-east of Jingdezhen in Jiang Xi Province), and "Pu Tong Ci 普通瓷" (translation: common ceramic). Kaolin is quite friable, and Putongci is a hard stone. Extracted into blocks, they are then broken into gravel by waterwheel and trip-hammer with a hard stone head, then reduced to a fine powder by rolling and falling stone balls into rotating wooden barrels or grinding wheels. These two machines were most often operated by a waterfall on a paddle wheel.

The powders are then decanted in cascading water tanks, where they lose their impurities that are deposited by decreasing particle size. The finest powders are used to make enamel. Pasta, mixtures of different grain sizes, are then kneaded and put to rest in blocks called balloons. This is the stage of "rot" that lasts for several days, during which a chemical transformation of the dough takes place. According to Marco Polo, the Chinese porcelain manufacturers let the decay act for several generations ...

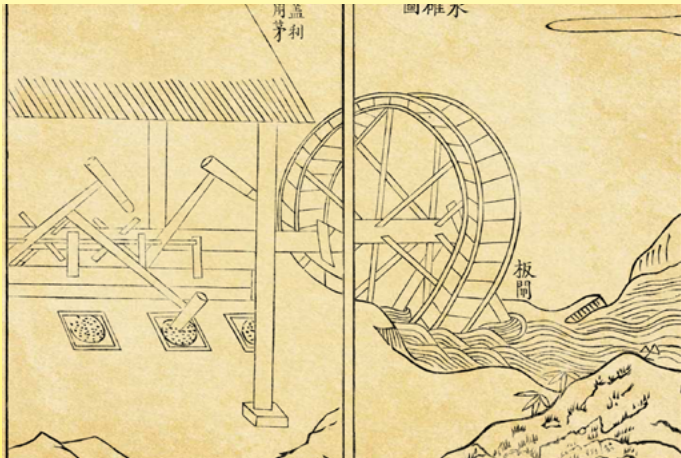

Waterwheel and trip-hammer (水碓 shui dui) for grinding minerals (Tiangong Kaiwu, Song Yingxing 1637)



Grinding of kaolin by grinders powered by an ox (1939, Vietnam, Economic Bulletin of Indo-China)



Traditional production machines ((水碓 shui dui) for production of powders used to make electric porcelain (private collection)



Traditional Chinese Dragon oven (龙窑 Long Yao), feeding mouth and filling method with electric porcelains (private collection)



In Europe, the secret of the manufacture of hard porcelain was first discovered by the chemist Boeticher at the court of Saxony, in the last years of the 17th century, by mixing different ores to make heat resistant crucibles. Its manufacture was immediately transferred to Meissen on the Elbe, near Dresden. Secret of state, manufacture of this porcelain, known since "Porcelain of Saxony" was particularly controlled.

Then, in two letters dated 1712 and 1722, the Jesuit missionary François Xavier d'Entrecolles described (with some inaccuracies) the manufacture of porcelain as he had discovered in China.

When he talks about kaolin, this ore is unknown in France. This white clay ore may contain up to 80% kaolinite of the molecular formula $Al_2Si_2O_5(OH)_4$, which is the active ingredient. It is especially its high concentration of alumina that gives it its high melting temperature, whiteness and hardness. But pure kaolin is almost infusible, and is not the only ingredient, and European scientists, after importing it, failed to make porcelain because they did not understand the importance of the second one. They lacked the "Putongci" this hard stone made of quartz and feldspar.

In 1727 and 1729 M. de Réaumur, in two memoirs read at the Sciences Academy in Paris, put forward the idea that the infusible Kaolin could only be one of the components and that the second ingredient, the Putongci, would help to melt by serving as a binder and lowered the melting temperature. On this basis, he succeeded in producing porcelain. Since these two materials did not have known equivalents in France at the time, things remained the same.



Historical introduction of ceramics used in connection blocks

Nearly 40 years later, in **1766**, the Comte de Lauragais presented hard porcelain at the Academy, without wishing to give the composition. In **1767** was accidentally discovered, by doctor Darcet's wife, the kaolin field at Saint Yrieix la Perche near Limoges. In **1768** after an examination of the material done by the Academy of Sciences, and tests made in **1769**, the first productions was started in Limoges in **1771**. This was the origin of the porcelain industry in Limousin.

Then Nicholas Christiern De Thy of Milly brought back from Dresden, where he had been able to visit various factories, the exact process of manufacture. He gave the description at the Royal Academy of Sciences on February 13, **1771**. From this, he made a book "The Art of Porcelain" in **1777**. Since then, hard porcelain began to be manufactured in France. It was reserved, by royal privilege exclusive to the Manufacture de Sèvres.

The revolution of **1789** put an end to this privilege, but porcelain remained confined to crockery and luxury decorative objects.

Little developed in France until **1840**, the manufacture of porcelain was not really industrialized until the **1880s** with the first steam engines and coal firing instead of wood.

The first uses in electrical circuits: The arrival of telegraph and porcelain insulators

In **1729**, Stephen Gray had defined the concept of conductors and insulators. At that time, electrostatic machines and laboratory apparatus required electrical insulators. First, glass was widely used. The first batteries also used glass as a container, but also as an insulator.

The arrival of the telegraph in the years **1855-1860** was at the origin of enamelled hard porcelain insulators used on poles for holding telegraph wires. It turned out then that those in porcelain were more insulating than those in glass. In England, ivory insulators were tried and found excellent for this purpose. Fortunately, they were not generalized any more than the bone insulators that were also considered.

As early as **1860**, telegraph lines used tens of thousands of porcelain insulators. Two years later, it was hundreds of thousands. Electric porcelain is then subjected to numerous tests, each producer having his recipe, often related to the composition of the existing ores nearby. Generally, it is a mixture of kaolin, clay, quartz and feldspar, baked around 1400°C. It is kaolin and clay that give its plasticity, while quartz is a degreasing element. The feldspar, whose melting point is much lower than those of the other constituents, ensures the vitrification of the mixture. The contents are substantially 50 percent kaolin, 25 percent feldspar, 25 percent quartz. Excellent electrical insulator, it is most of time waterproof, acid-proof and can withstand great temperature change without cracking. Its enamel provides a smooth and non-porous surface.

At the Universal Exhibition of **1878**, two Paris producers of porcelain insulators are already exhibiting.

Three years later, at the International Electricity Exhibition in **1881** in Paris, there are already a dozen producers of insulating porcelain pieces, for telegraphy but also for electrical networks and circuits that are beginning to appear. In **1888** porcelain insulators are universally used on utility poles for street lighting.

At the end of the 19th century, its use became progressively common in most domestic electrical appliances: lamp-holders for light bulbs, switch boxes and sockets, plugs, bases and supports of heating resistors, junction boxes, fuse holder, etc.

In **1892** was founded in Paris, rue des Arquebusiers, the Pertus company which began to produce porcelain parts for electricity. (This company closed in **2004**)

At the World Exhibition of **1900**, electric ceramics were present in many forms: insulating pieces, but also insulating enamels (Godin to Guise), sintered heating rods comprising conductive powders, porcelain insulating pieces (Parvillée Frères).

It should be noted that the pioneering work of the brothers Achille and Louis Parvillée in resistive ceramics was widely commented as early as **1900** in international technical journals in Germany and the USA. The technology of the high-temperature sintered powders they developed in Paris, 26 Gauthery street and after **1898**, in their new factory in Cramoisy (Oise), gave rise to very high-temperature silicon carbide heating resistances, such as Silite, around **1913**, Globar, around **1926**.

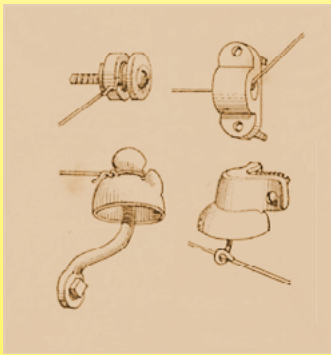

1881 Porcelain insulators for electrical distribution and battery-based bell circuits (Dictionnaire des termes employés dans la construction, Pierre Chabat)



1885 Porcelain electrical insulators (La physique moderne : l'électricité dans la maison, É. Hospitalier)



1918 Parvillée's Insulators and heating appliances (Revue Générale de l'électricité)

The arrival of electrical insulated porcelain terminal blocks

In **1905**, the increasing number of electrical applications of porcelain made competition very important, and the price fell sharply. Competition with German and Austrian producers was fierce.

In Germany, the manufacture of small electrical insulating porcelain was done with moistened powders compressed by manual shock or pedal presses. In France, this technology was invented in 1890 by the Gardy company, manufacturing electric porcelain in Argenteuil, using steel dies. The process consisted in producing a granulate moistened with a mixture of oil and water: 0.2 to 0.3 parts of vegetable oil, 1.0 to 1.5 parts of petroleum oil and 2 to 3 parts of oil. To 100 parts of paste were added 12 to 17 parts of this mixture. (Later this mixture will be replaced by diesel oil). The wet powder was then passed by hand through a sieve; The quantity of powder required was placed in molds, where it was compacted by shock presses. In a more artisanal version, the pieces were pressed by closing the mold and striking it with a hammer. Demoulded, the terminal block was then left to dry for several days before being covered with a layer of enamel and fired. This method gave many rejects: due to the inhomogeneity of the powders, the irregularity of the quantity placed in the mold and the irregularity of the pressures exerted produced cracks, and the porcelain was porous. For these reasons, electricians at the time considered that porcelain was a bad insulator and that only the enamel layer was insulating. In **1902-1905** The insulating characteristics of electric porcelain were not absolutely analyzed and understood. (Research by M.S. Watts in Transactions of the American Ceramic Society, IV, 1902, 86; La Ceramique, 1903, pp. 3 and 19; Sprechsaal, 1903, pp. 519 and 557)

Because of permanent improvement of our products, drawings, descriptions, features used on these data sheets are for guidance only and can be modified without prior advice



Historical introduction of ceramics used in connection blocks

Because of permanent improvement of our products, drawings, descriptions, features used on these data sheets are for guidance only and can be modified without prior advice

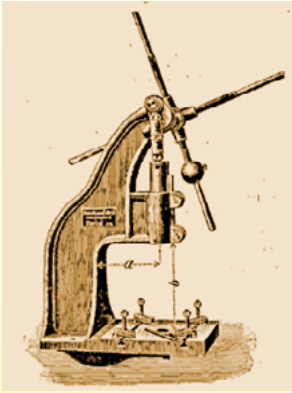

German manual shock press for electric porcelain (1905 La Céramique Industrielle, A. Granger, Ultimheat Museum)

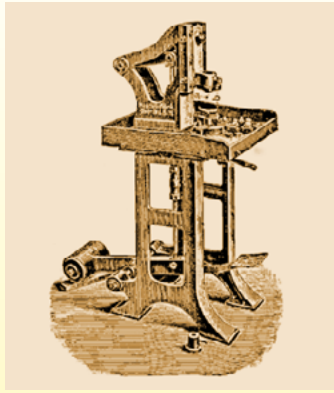

German pedal press for electric porcelain (1905 La Céramique Industrielle, A. Granger, Ultimheat Museum)



Porcelain Terminal Blocks Hand Made by Hammer Pressing: Manual Filling of Wet Granulate (Private Collection) Drying of Electric Porcelain After Pressing (Private Collection)

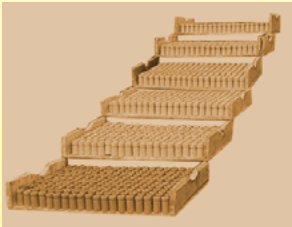

Drying of porcelain insulators after hand hammer pressing (Private Collection)

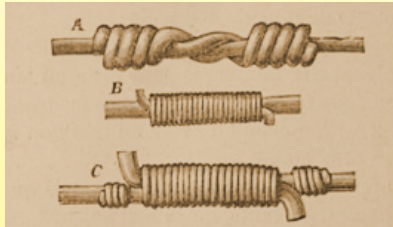

The junction of the electrical wires by splicing in 1892 (Manuel pratique de l'installation de la lumière électrique, Installations privées, by J.-P. Anney)

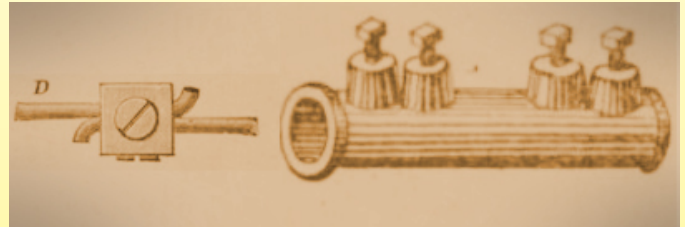

1892 Screw terminals (Manuel pratique de l'installation de la lumière électrique, Installations privées, by J.-P. Anney)

In **1911** was printed a book often referenced on the manufacture of porcelain insulating pieces: « Les substances isolantes et les méthodes d'isolement utilisées dans l'industrie électrique, by Jean Escard ». If the author specifies the average compositions of electrical porcelains, his data on the variation of the electrical resistivity as a function of the temperature are fragmentary and limited, and also show that in the minds of the builders, the glazing is more important than the composition of the porcelain. It dedicates only 3 lines to the uses of porcelain in switch bases, lampholders and other small components. In **1919**, in Paris, at the instigation of the "Comptoir des fabricants de produits réfractaires", a ceramic testing laboratory was created. The same year, a decorative porcelain manufacturer from Limoges, Frédéric Legrand joined forces with Jean Mondot, director of the Mondot Company, Vinatier and Jacquetty, who had manufactured in Exideuil in Dordogne, since **1905**, porcelain electrical switches for household lighting. From this association will be started the electrical division of Legrand.

The years **1920-1930**, following the development of electrification, will see a huge development of the electrical components industry and many other manufacturers will put porcelain terminal blocks to their catalog : Moor, Fournet, Bouchery, Samet, Pétrier, Thomson etc. Porcelain terminal blocks, of small dimensions, sometimes without fixing holes are then mainly used in the domestic wiring of the lighting networks, replacing splices covered with chatterton. Some will have 2 set screws for each driver.

In December **1923** was inaugurated, in Ivry-Port near Paris, a laboratory intended for the test of the insulating ceramics able to produce electric discharges reaching a million volts. (The Journal, December 12, 1923)



1925 Terminals: single-wire, two-wire, three-wire without mounting hole (Pétrier Catalog, Ultimheat Museum)



1925 Two-wire junction terminal without hole (Thomson Catalog, Musée Ultimheat)



1950 Terminals with fixing hole (Moor Catalog, Musée Ultimheat)



1931 Junction boxes and porcelain junction terminals (Maure Catalog, Musée Ultimheat)



Historical introduction of ceramics used in connection blocks



1933 Porcelain Junction Terminals with and without Mounting Hole (Bouchery Catalog, Ultimheat Museum)



1933 Porcelain joint junction without hole (Fournet Catalog, Ultimheat Museum)

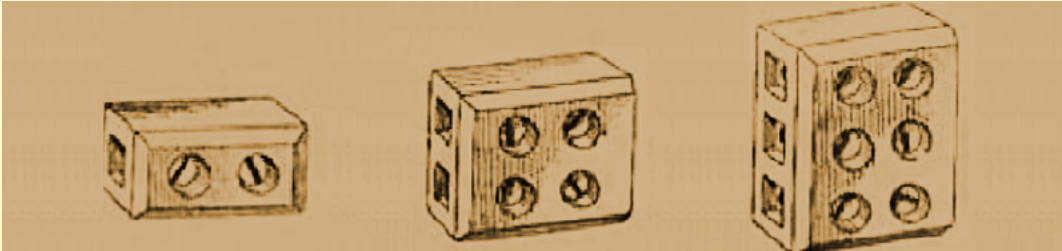

1936 Porcelain Junction Terminals without Fixing Hole (Samet Catalog, Ultimheat Museum)

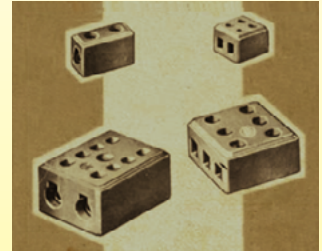

1963 Porcelain junction terminals with and without fixing hole (Legrand Catalog, Musée Ultimheat)

Because of their resemblance, especially for those of the two-wire range of Legrand, porcelain terminal blocks were called "dominoes" by the electricians. Because of their shape and whiteness, they were also called "sugar cubes". They were widely used in the connections of electric stoves and ovens which developed strongly in the 1930s. The fixing hole appeared then, to allow the assembly of the terminal blocks on the sheet metal work. But this new application, especially in electric stoves ovens, showed limits to their temperature resistance: at 150°C the porcelain gradually loses its dielectric properties as temperature increases. Above 300 ° C, it undergoes chemical transformations that make it a bad insulator, especially for electric porcelain with a low percentage of kaolin.

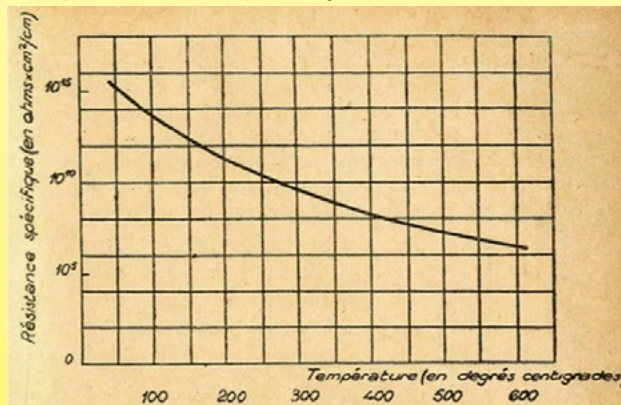

Variation of the specific resistance in ohms.cm/cm² of the porcelain according to the temperature (logarithmic curve). Between 20 ° C and 300 ° C its resistance is divided by 10,000 (1945 Matériaux électrotechniques modernes, Ultimheat Museum)

Evolution of diameters and cross-sections of electrical conductors

| SECTION des câbles en millimètres carrés | COMPOSITION | DIAMÈTRE | |
|--|-------------|----------------------------|------------------------|
| | | du fil employé millimètres | des câbles millimètres |
| 5,0 | 5 fils | 1,14 | 3,2 |
| 10,0 | 10 — | 1,14 | 4,6 |
| 19,0 | 19 — | 1,14 | 5,7 |
| 20,0 | 20 — | 1,14 | 6,9 |
| 25,1 | 19 — | 1,3 | 6,5 |
| 31,4 | 10 — | 2,0 | 8,8 |
| 34,5 | 11 — | 2,0 | 8,0 |
| 40,7 | 13 — | 2,0 | 8,6 |
| 44,0 | 14 — | 2,0 | 8,8 |
| 50,2 | 16 — | 2,0 | 9,4 |

1907 Diameters of electric wires (Agenda Dunod de l'électricité, Ultimheat Museum)

| S = Section en mm² | | t = Température ambiante | | o = Échauffement au-dessus de la température ambiante | | | | | | | | | | | |
|--------------------|------|--------------------------|------|---|------|-----------|------|------------|------|-----------|-----|-----|-----|-----|------|
| C | S | t = 20° C | | t = 40° C | | t = 20° C | | t = 40° C | | t = 20° C | | | | | |
| | | A | D | A | D | A | D | A | D | A | D | | | | |
| 1 x 7/10 (I) | 0,38 | 6,5 | 17,1 | 5,5 | 14,5 | 4 | 10,5 | 19 x 12/10 | 21,5 | 75 | 3,5 | 59 | 2,7 | 39 | 1,8 |
| 1 x 9/10 (I) | 0,64 | 7,5 | 11,7 | 6,5 | 10,1 | 5 | 7,8 | 19 x 14/10 | 29,3 | 90 | 3,1 | 70 | 2,5 | 45 | 1,5 |
| 1 x 12/10 | 1,13 | 10 | 8,8 | 8,5 | 7,5 | 7 | 6,2 | 19 x 16/10 | 38 | 107 | 2,8 | 83 | 2,2 | 51 | 1,3 |
| 1 x 10/10 | 2,01 | 14 | 6,9 | 12 | 6,0 | 10 | 5,0 | 19 x 18/10 | 48 | 125 | 2,6 | 95 | 2,0 | 58 | 1,2 |
| 1 x 20/10 | 3,14 | 18,5 | 6,9 | 16,5 | 5,2 | 13,5 | 4,3 | 18 x 20/10 | 60 | 143 | 2,4 | 108 | 1,8 | 65 | 1,1 |
| 1 x 25/10 | 4,91 | 25 | 5,1 | 22,5 | 4,6 | 17,5 | 3,6 | 37 x 10/10 | 74 | 165 | 2,2 | 125 | 1,7 | 73 | 1,0 |
| 1 x 30/10 | 7,07 | 32,5 | 4,6 | 29 | 4,1 | 22 | 3,1 | 37 x 18/10 | 94 | 193 | 2,1 | 145 | 1,5 | 82 | 0,85 |
| 1 x 34/10 | 9,08 | 39,5 | 4,3 | 34,5 | 3,8 | 25,5 | 2,8 | 37 x 20/10 | 116 | 225 | 1,9 | 165 | 1,4 | 90 | 0,75 |
| 7 x 9/10 | 4,45 | 23,5 | 5,3 | 21 | 4,7 | 16,5 | 3,7 | 37 x 22/10 | 141 | 257 | 1,8 | 187 | 1,3 | 100 | 0,70 |
| 7 x 10/10 | 5,5 | 27 | 4,9 | 24,5 | 4,4 | 19 | 3,5 | 37 x 24/10 | 167 | 290 | 1,7 | 210 | 1,2 | 110 | 0,65 |
| 7 x 12/10 | 7,92 | 35,5 | 4,5 | 31,5 | 4,0 | 23,5 | 3,0 | 37 x 26/10 | 196 | 325 | 1,6 | 235 | 1,2 | 120 | 0,60 |
| 7 x 14/10 | 10,8 | 45,5 | 4,2 | 39 | 3,6 | 27,5 | 2,5 | 37 x 28/10 | 228 | 365 | 1,6 | 260 | 1,1 | 130 | 0,55 |
| 7 x 16/10 | 14,1 | 55,5 | 3,9 | 45 | 3,2 | 31,5 | 2,2 | 37 x 30/10 | 262 | 405 | 1,5 | 285 | 1,1 | 140 | 0,50 |
| 7 x 18/10 | 17,8 | 66 | 3,7 | 49 | 2,9 | 35,5 | 1,9 | | | | | | | | |

1933 Diameters of electric wires (Bouchery Catalog, Ultimheat Museum)

In the early days of the manufacture of copper electrical cables, preference was given to limiting wire diameter ranges, and the section in mm² of the cables was only the consequence of wires diameters and not the basis of the cable sections. In 1910, a series of sections of conductors was proposed identical to that of the current standards: 0.75mm²; 1; 1.5; 2.5; 4; 6; 10; 16; 25; 35; 50mm². (Aide-mémoire de poche de l'électricien par Ph. Picard, et A. David) But this attempt at standardization did not last, it was the cable manufacturers who, according to their manufacturing requirements, fixed the cross-sections. In the Bouchery catalog of 1933, answering the specifications established by issue 137 of the "Union des Syndicats de l'Electricité", it is no longer the section which serves as a reference in the series, but the diameter of the conductors, established in 10th of a mm: 7/10; 9/10; 12: 10; 16: 10.20 / 10; 25/10; 30/10; 34/10 etc. In 1954, a beginning of normalization according to the section in mm² appears for the wired conductors: 5.5mm²; 8mm²; 10mm²; 14mm²; 18mm²; 22mm²; 30mm²; 40mm²; 50mm² etc., but the rigid conductors are always given in 10th of a mm: 12/10; 16/1; 20/10, 25/10; 31.5 / 10.



Historical introduction of ceramics used in connection blocks

In **1963**, Legrand still gives the following relationships for its porcelain terminal blocks:

- Dia 2.5 for 3mm² conductor
- Dia 3.5 for 5.5mm² conductor
- Dia 4.5 for 10mm² conductor
- Dia 5.5 for 18mm² conductor
- Dia 8.5 for 40mm² conductor
- Dia 9.5 for 50mm² conductor

In **1983** the sections of the wires were standardized, the 3mm² became 2.5mm², the 5.5mm² became 6mm², the 18mm² became 16mm², the 40mm² became 35mm². The 4mm² and the 25mm² were created.

Currently it is the IEC 60228 standard that defines the standard sizes of conductors in electrical cables.

Steatite

Steatite was known by many names,

- Under the name of ollare stone or potstone, (from the Latin "ollarius": used to make pots), because the fineness of its grain, its little hardness, its inalterability to fire allowed to turn around the pots and cauldrons. This feature is still known by current artists who use it because it is soft and easy to carve.
- Under the name of talc, for its touch soft powder version

- Under the name of steatite, to describe its fire-hardened version. In this form, Johann Heinrich Pott¹ describes that before **1700** the inhabitants of the mountain Fichtelberg harden this stone by firing to put it in a state of being polished to make small balls, buttons and send loaded full carts in Nuremberg,

(1) "Lithogéognosie, ou Examen chimique des pierres et des terres en général et du talc, de la topaze et de la stéatite en particulier". French edition of 1753.

At the beginning of the 19th century, it was used for the manufacture of cameos and other decorative objects.

But it was the industrialists of the Nuremberg region who used the peculiarity of this mineral as early as **1854-1855**, to give after cooking a hard and heat-resistant ceramic for a new application: the gas burners. The main suppliers were Johan Von Schwarz and Jean Stadelmann from Nuremberg, both of which were the main owners of the only known steatite mines known at that time. They were grouped in a union called "Gas Burners" including the 6 producers of Nuremberg plus Lauboeck and Hitpert de Wunsiedel in Bavaria.

As early as January **1856**, Johan Von Schwarz had filed a patent in France on the ways of hardening soapstone and alumina silicates.

For 40 years, steatite did not find other industrial opportunities.

Around **1894**, acetylene lighting began to develop, which had the inconvenient to produce a very hot flame that destroyed the burner nozzles. At the Universal Exhibition in **1900**, a Parisian engineer, Louis M. Bullier, won a gold medal for his steatite gas acetylene nozzle patented in March **1895**. (Louis Bullier, Henri Moissan's collaborator, had participated in the production first electric furnaces for the manufacture of calcium carbide and invented, besides an industrial method for the production of calcium carbide, the first functional burner nozzles for acetylene lighting)

Little known, except for this application, steatite is mentioned only for memory in **1905** in the course of the professor A. Granger on industrial ceramics. Its recent applications in electrothermal and lighting were still too limited and recent.

Shortly after, around **1907**, the "Société Française d'Articles en Stéatite", 10 place des Vosges, also began manufacturing steatite parts for electrothermal applications.

The need for automotive sparkplug insulators and high-temperature insulators for electric heating provided new opportunities.

To introduce himself in this new booming market, in **1908**, the domestic porcelain manufacturer Philipp Rosenthal & Co. AG acquired the Thomaswerke factory in Marktrechwitz, opening its activity to electro-technical porcelain.

In **1911** Jean Escard (*) considers soapstone as a good insulator, which has only been used for a short time in electric insulating plates and spark plugs, than in its native form, easy-to-machine soapstone. but with limited mechanical strength, inferior to porcelain and marble. Its use in high-temperature baked form like porcelain is apparently not known to him. (*: Insulating substances and insulation methods used in the electrical industry)

Thanks to its technical advance and the quality of the soapstone from their mines, the German Nuremberg Trade Union maintained a near-global monopoly and controlled prices on the production of steatite parts, burner nozzles, car sparkplugs insulators and heating resistances insulators until **1914**.

The blockade of the First World War intensified the search for ore outside Germany and ended the monopoly, but the lobby of the German producers remained intact and comforted Germany's advance in the electro-technical ceramics industry.

In **1921** Rosenthal began to cooperate with the manufacturer AEG for the manufacture of technical porcelain, and in **1936**, the two joined to create Rosenthal Isolatoren GmbH which became one of the major actors of the sector.

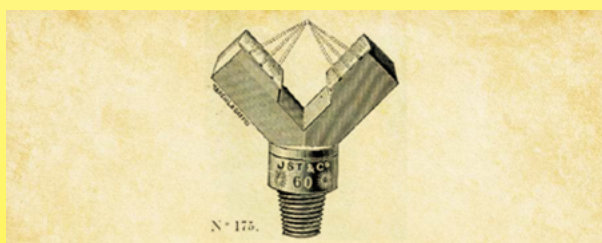

Stadelmann's Gas burners heads in steatite (1906, Catalogue des becs Hella, Ultimheat Museum)



Paris office of Jean Stadelmann of Nuremberg, (1908 letter head, Ultimheat Museum)



Pertus's electrothermal steatite (Ultimheat Museum)

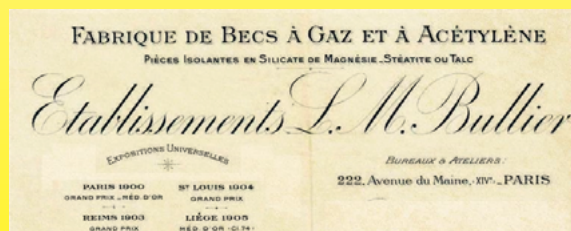

1912 L.M. Bullier, Paris, insulating steatite parts (letter head, Ultimheat Museum)

On 21 November **1916**, since the blockade deprived France of the German steatite needed for cars sparkplugs, they became a critical military component. The industrialist Jules-Edouard Delaunay, 88, boulevard du Port-Royal, and the chemist Georges-Louis Dimitri, 7, rue Victor Considérant, then took in France, the patent n° 505.386 for the manufacture of compressed steatite. This patent was completed by a second, No. 498.015, dated July 16, **1918**. This material was quickly recognized as the perfect insulator for car sparkplugs, but also for the heaters and burner nozzles for gas lighting. It consisted mainly of 61.8% silica, 28.1% magnesia and 5.1% alumina. It combines hardness, electrical insulation at high temperatures and high frequencies, and resistance to high temperatures.



Historical introduction of ceramics used in connection blocks

In **1919** was founded a competing company "Industrial Steatite, Ets E. Robert and Co." in Montreuil-sous-Bois, which specialized in the manufacture by compression of insulating parts for electrothermal equipment.

Jules-Edouard Delaunay and Georges-Louis Dimitri applied for the mark Isolantite on August 3, **1920**, and thanks to the close relations taken during the war with an American industrialist, Major De Caplane, was also set up the company Isolantite USA, which then in a few years became the largest American specialist in ceramic insulation in the booming radio industry.

In **1927**, on October 18th, in the wake of the success of the Isolantite, was created the S.A. L'Isolantite, at 52, boulevard Garibaldi in Paris.

In the years **1925-1930**, the German industry of steatite and industrial porcelain, was in the hands of a main group: the "Steatit-Magnesia AG" (Stemag AG) founded in **1921** in Hollenbrunn near Lauf on Pegnitz in Bavaria, a traditional center of ceramics and steatite. This company, developing in Europe, took control in **1928** in England of Steatite and Porcelain Products Ltd. in Stourport-on-Severn, Worcestershire.

In France, this group created the Steatit-Magnesia factory at 206 rue Lafayette in Paris. In **1970** the group joined AEG, then in **1971** with Rosenthal to become Rosenthal Stemag Technische Keramik GmbH.

In Europe and USA, many types of electrotechnical ceramics with various characteristics were developed in the years **1930-1940**, among which we can mention: Sinterkorund, Isomar, Pyranite, Pyrodur, Calite, Calan, Frequenta, Ardostan, Sipa, Condensa, Kérafar, Rheostite, Calodure, Aloska, Morganite, Global ... Each manufacturer of technical ceramics giving a name to a type of product. The French company L. Desmarquest et Cie, specialized since the beginning of the 19th century in ceramic crucibles with a high percentage of alumina, began manufacturing insulators for heating resistances under the brand name Ohmolithe.

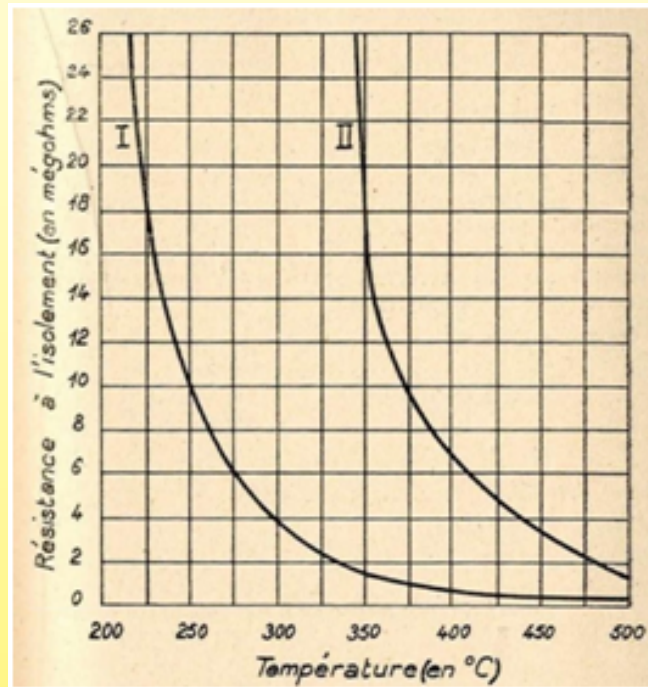

1945 Variation of insulation resistance between porcelain (I) and steatite (II), measurements made on identical specimens (1945 Matériaux électrotechniques modernes, Ultimheat Museum)

Immediately after the Second World War, when due to lack of fuel, heating and especially cooking gave preference to electricity, steatite will become the preferred electrical insulation for high temperatures. Thermally and mechanically resistant, (vibration and shock), retaining good insulating properties at high temperature (up to 600°C) it will be and will remain used in a large range of electrical industries inside spark plugs, switchgears, heating elements, railway radiators, liquid heaters, heating switches, insulating beads, hotplate connector bases etc ...

It was naturally chosen for the manufacturing of terminal blocks to withstand temperatures above 250-300°C.

In this **1949** catalogue of Arthur Martin electric stoves, one can see the use of dozens of steatite parts.

In certain applications where dust caused by the condensation of moisture may appear, it was sometimes glazed.

Depending on the type of atmosphere of the firing oven used, it can be white (reducing atmosphere) or yellow (oxidizing atmosphere).

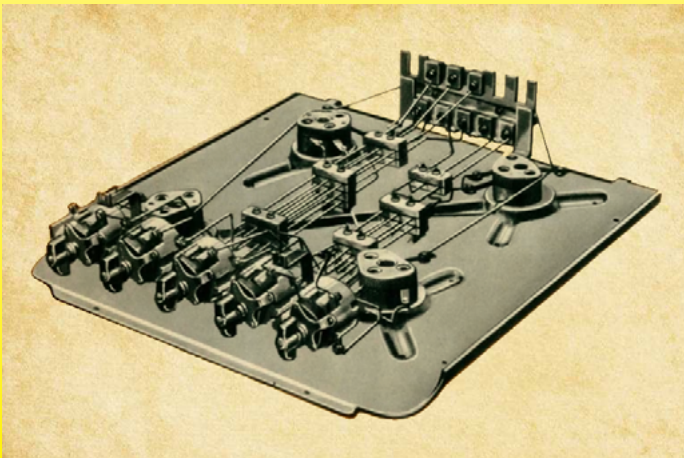

Electrical wiring of the top of an Arthur Martin electric stove (Catalog 1949, Ultimheat Museum). Insulating pieces in steatite and porcelain are omnipresent



1938 Steatite insulating parts for electrothermal (1938 Catalog La Stéatite industrielle, Ultimheat Museum)

Because of permanent improvement of our products, drawings, descriptions, features used on these data sheets are for guidance only and can be modified without prior advice



Historical introduction of ceramics used in connection blocks

Automation of the die casting of ceramics

In **1930**, Isolantite USA began to automate the compression molding of steatite by modifying pressing machines for pharmaceutical tablets (James Millen, August, 1937 issue of QST magazine p.65).

In the early **1960s**, a new technique of injection molding of steatites, and in general ceramics, called low pressure injection, was invented in Russia by P.O. Brobosky. (P. O. Gribovsky: 'Hot casting of ceramic products', 1961, Moscow Leningrad, GosEnergoizdat)

Injection molding technology relies on the ability of ceramic mixtures, prepared with a specific polymer binder and heated to a certain temperature to have the consistency of modeling clay, and to flow under pressure, into metal molds. When the part is cooled in the mold, it solidifies, and can then be demolded and fired. The binder is then vaporized during firing. In the **1970s** two main methods of injection molding were developed. Their main difference is the type of temporary binder and the associated pressure applied. Because of these differences, there is a distinction between equipment used for shaping ceramic components and the process for removing binders. The first method, called high-pressure injection molding, relies on the use of thermoplastic organic compounds, which become fluid at temperatures of 150 to 300°C (polypropylene, polystyrene). In this case, a ceramic powder is plasticized with this binder in the temperature range where it is melted, cooled and cut into pellets. These granules are then heated and introduced into the injection machine. The shaping is carried out under fairly high pressures (5-70 MPa) in metal molds. After demolding, the part obtained is subjected to combustion of the binder during a subsequent firing.

Another method, called low-pressure injection molding, relies on the use of thermoplastic organic compounds, which become fluid at relatively low temperatures, of the order of 60-70°C. The main component of this binder system is paraffin wax, which melts at this low temperature. Because the paraffin-based ceramic polymer compositions have a rather low viscosity and good fluidity, very softness and plastic properties at rather low temperatures, these compositions require only low pressures (0,2-0,7 MPa). In this case, a ceramic powder is mixed and plasticized with this paraffin binder system at 60-70 °C and the prepared composition is injected into the metal molds. When the mold is cooled, the part is ejected. The paraffin is then vaporized at high temperature in an oven and then the ceramic is fired.

Manufacturers of special automatic machines for the production by molding of ceramic parts by low pressure injection were born in the 70s. The oldest seems to be in **1978** Peltsman Corporation in the USA. These methods revolutionized the manufacture of ceramic technical parts.

The arrival of thermoset plastics and thermoplastics.

The arrival of thermosets in the **1930s** allowed the manufacture of many electrotechnical parts by thermocompression, but did not replace the ceramic in the terminal blocks. In its catalog of **1932**, where it describes itself as "Only French house currently manufacturing a set of small equipment Bakelite" the Company Maure uses Bakelite only for lids and boxes, and keeps the ceramic for the bases and supports of terminals.

But Bakelite was a revolution in the small electrical apparatus, for all the structural elements.

"Over the last twenty years, the multiplication of materials used or usable in electrical engineering has been such that it has become difficult for an engineer to know all their particularities ... with so-called plastic materials used as insulators or dielectrics we see the electrotechnical applications undergo profound changes ". (1945 Matériaux électrotechniques modernes, Ultimheat Museum)

The arrival of thermoplastics around **1955** allowed the invention of flexible nylon terminal blocks. But none of these materials allowed use at temperatures above 150 °C.



"Nylbloc" terminal blocks
(1963 Legrand Catalog, Musée Ultimheat)

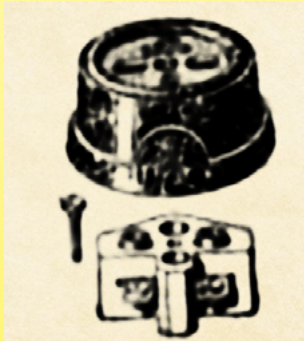

Power socket with porcelain base and bakelite lid
(1932 Maure Catalog, Ultimheat Museum)



Bakelite terminal
(1933 Bouchery Catalog, Ultimheat Museum)

Rising of electrical standard



1926 Marking AP-EL (Société pour le Développement des Applications de l'Électricité)



1932 Marking APEL-USE (Société pour le Développement des Applications de l'Électricité et Union des syndicats de l'électricité)



1932 ca USE marking on Maure porcelain terminal blocks



1932 USE marking on small electrical components (Maure catalog)



1956 Marking APEL-USE-NF



1957 Marking USE printed with the standard number (C32) and the manufacturer identification number (295)

As early as **1887**, the " Journal du Gaz et de l'Electricité", at the instigation of an insurance company, published the first known regulation on the safety instructions to be taken for the installation of electric lighting. This regulation specified that "the size of the wires must be proportioned to the current which must cross them so that the temperature does not exceed 80 degrees centigrade, ... the junctions of the wires will have to be electrically and mechanically perfect", but without specifying more.



Historical introduction of ceramics used in connection blocks

The law of June 13th, **1906** on the distribution of energy added an imperative of additional security by specifying that the losses of current through the insulation could not exceed 1/10.000th of the current which circulated there. (For a 230V 10A circuit, this gives a value of the insulation resistance of 230 kΩ). In **1907** was founded an electrotechnical standardization body: "l'Union des syndicats de l'électricité" (U.S.E.) at the initiative of the Professional Union of Electrical Industries and the Professional Union of Electricity Plants. This body gradually implemented a standardization of equipment, components, wires and cables.

In **1915**, the inter-union brand UNIS-France was created, awarded to manufacturers guaranteeing the French origin of their products.

In **1922**, was founded the " Société pour le Développement des Applications de l'Électricité (AP-EL)", by the Parisian Company of Distribution of Electricity and the sectors of the Paris area, which establishes a first quality mark then called "The Hand that marks" for household appliances. However, it did not apply to components or small equipment.

In **1925**, the U.S.E quality mark was created by the Union of Electrical Equipment Manufacturers. It applied to small electrical equipment, including terminal blocks. It had been made necessary because of the increasing competition between the manufacturers, which was lowering the quality of the products.

In **1927** it became the USE-APEL mark.

The first normative regulation for the components appeared in **1928** in the publication no. 67 of the USE: "Rules of establishment of the small electrical equipment for a maximum current of 25 amperes". In the third part, a series of specifications for ceramic terminal blocks were defined: insulation, spacing of live parts, partitioning, terminal hole diameter, wire clamping, copper cross-section, electric contact surfaces.

Some terminal blocks began to bear this "USE" mark.

The devices were regulated at the same time by Publication No. 184: "General and Private Technical Regulations Established for the Granting of the USE-APEL Quality Mark to Appliances".

Following the appearance of plastic materials, the USE published in **1935**, a pamphlet No. 46, "Test methods for molded insulators", which was modified and completed in **1941** by the "Methods of testing plastics". used in electrical construction ". These tests defined methods and specimens whose current standards are directly derived.

The U.S.E. was renamed in **1938**: U.T.S.E "Union Technique des Syndicats de l'Electricité",

In **1939** appears the mark of quality NF, attributed by the Afnor, which will become effective only after the second world war. The APEL then adds to its logo the NF mark.

In **1947** the ""Union Technique des Syndicats de l'Electricité"" became the " Union Technique de l'Electricité (UTE)". The USE logo for the components was not changed.

In **1951**, the dimensions of copper electrical conductors were standardized by standard NF C19, and the rules of construction of small apparatus by circular No. 67, domestic installations by the rule USE 11 and its circular No. 11.

In **1957**, the standard NF C11 specified that in domestic installations, the **junctions and derivations of the conductors will preferably be made using screw connection devices** or equivalent, attempting in this way to terminate the splices covered with "Chatterton tape" which were widely practiced.

When they first appeared in the early **1970s**, the international electrical safety standards for household electrical appliances (IEC 60730 and IEC 60335 series) clearly differentiated between ceramic and thermoplastic and thermosetting insulators, giving the best insulation characteristics to ceramics, including a CTI above 600, and many test exemptions. They also gave a maximum limit temperature for internal brass parts (210°C), nickel-plated brass (185°C), nickel-plated steel (400°C), and stainless steel (400°C). Their recent evolutions favored ceramics even more.

In **1990** appeared the **most current standard for electrical terminal blocks**: IEC (EN) 60998 and in particular part 2, "Connecting devices for low-voltage circuits for household and similar use - Part 2-1: special requirements for safety devices". connection as separate parts with screw clamping devices ". This standard redefines in particular several critical parameters:

1 / - The maximum heating of the terminals by Joule effect (45°C) according to the current.

2 / - The test currents according to the passage sections, found on the terminal blocks of some manufacturers. (24A for 2.5mm², 32A for 4mm², 41A for 6mm², 57A for 10mm², 76A for 16mm², 101A for 25mm²).

3 / - Leakage lines and distances in the air, which are 4mm for voltages > 250 and ≤450 V and 6mm for voltages > 450 and ≤750 V. These distances apply between conductors of different polarities, the conductors and the mounting bracket and the possible metal box covering the terminals.

4 / - The minimum value of the isolation which must be greater than 5 MΩ,

5 / - The value of the dielectric test voltage of one minute, which must be 2500V for a terminal block designed to operate from > 250 to ≤450V and 3000V for a terminal block intended to operate from > 450 to ≤750V .

It was supplemented by IEC (EN) 60999 for cross-sections greater than 35mm².

A second reference standard appeared at the same time for terminal blocks: The EN 60947-7-1 standard first published in **1989**, now in its version of August **2009**, which describes the terminal blocks for copper conductors in industrial applications. It incorporates a large part of the above standards but includes in particular an article which defines a **minimum voltage drop of 3.2mV at the terminals for an intensity equal to 1/10 of the maximum test intensity at the maximum temperature conditions**.

For terminals of 6mm², and a current of 4.1A this corresponds for example to a resistance of the order of 0.78 milliohms. For terminals of 50mm², this resistance becomes 0.21 milliohms under a current of 15A.

In the case of terminal blocks to operate at high temperature, **this specification is critical**.

In this standard, the threshold value for air distances and creepage distances of 450V does not exist. Thresholds are 250V, 400V and 600V.

It is good to know that in these two standards, except T marking followed by a temperature, the maximum ambient temperature of the terminal blocks in normal operation is 40°C. Nor is there any predicted temperature class above 200°C.

The standards on ceramics

As early as **1900**, in addition to steatite, German industry had already begun to develop high-temperature ceramics with a high percentage of alumina (**1900** Quincke, ceramic insulators for very high temperatures. XL, pp. 101-102.).

If the WWI had ended for a time export of German technical ceramics, their development of this industry quickly made Germany the world's leading producer. It was therefore logically this nation that was the first to set standards on the composition and characteristics of technical ceramics.

In **1974** appeared the German standard VDE 0335-1 (DIN 40685-1): Specifications for ceramic insulating materials, classification, obligations, type.

Ceramics are classified into families according to their general compositions and their insulating characteristics. In particular the evolution of the temperature resistivity is clearly defined.

In **1997**, this German standard was adopted in the IEC 60672-3 standard: Ceramic and glass insulators, specification of materials.

Because of permanent improvement of our products, drawings, descriptions, features used on these data sheets are for guidance only and can be modified without prior advice



Because of permanent improvement of our products, drawings, descriptions, features used on these data sheets are for guidance only and can be modified without prior advice

Technical introduction to ceramic and PA66 connection blocks



Because of permanent improvement of our products, drawings, descriptions, features used on these data sheets are for guidance only and can be modified without prior advice

Technical introduction of connection blocks made in ceramic and polyamide



Because of permanent improvement of our products, drawings, descriptions, features used on these data sheets are for guidance only and can be modified without prior advice

Introduction

The problem of the temperature resistance of the ceramic terminal blocks is only very slightly addressed by the existing standards. If the porcelain terminal blocks, the first ones to have been developed at the beginning of the 20th century, used ceramic as an insulating material, it was because there was no other economical electrical insulating material that could be molded at the time, and having sufficient mechanical strength. Temperature resistance in domestic electrical installations was a secondary parameter.

Gradually, however, ceramics have given way to plastics in everyday applications. Ceramic (porcelain and steatite) is only used in applications where mechanical strength and resistance to high temperatures are preferred and cannot be achieved with thermoplastics or thermosets.

The standards write little of these applications, and the T200 marking provided in some is insufficient for ceramics.

While some obvious test exemptions for ceramic insulators are provided for in electrical standards, these do not differentiate between types of ceramics, and their insulating properties at high temperatures are ignored. It is the same for the temperature resistance of the metals used for the electrical terminals.

In recent years, there has been a need for increasingly high temperatures, far above 200°C, for example the fire resistance standards for cables: NFC3270, IEC 60331, EN50200, DIN VDE 0472 part 814, BS 8434-2, BS 6387 A, B, C, S etc.

These standards have different temperature resistance values, ranging from 650°C for 30min to 950°C for 180 minutes.

The few scattered information of standards for resistance to high temperatures are insufficient: for example the standard EN60730-1 (controls for household appliances) gives a maximum ceramic temperature of 425°C in §14-1; 200°C on 6.35 nickel-plated brass tabs, and 230°C for un-plated brass terminals; 400°C to steel ... More, there is no mention of special temperatures for nickel.

In order to correctly quantify the possibilities of the ceramic terminal blocks, we thought it would be useful to give the engineering departments appropriate technical elements.

First section : Insulation parts of connection blocks

Electrical and mechanical characteristics of ceramics used in connection blocks

The different ceramics used in terminal blocks and electrical insulating parts are distinguished by their composition, their method of manufacture, and especially by their insulating capacities (resistivity) as a function of temperature. In terminal block applications, their high frequency dielectric characteristics are not an important criterion. All these ceramics are of course non-flammable, and classified with a comparative tracking index (CTI) greater than 600 in electrical standards, this is the highest class of resistance to surface currents.

The reference standard for these ceramics is IEC (EN) 60672.

The ceramics of the C100 group

The basic components of Ceramics group C100 (Alkaline alumino silicate porcelain) are quartz, feldspar and kaolin, which are similar to decorative and household porcelain.

The C111 Porcelain: It is a pressed siliceous porcelain with an open porosity of not more than 3% and whose dielectric strength varies according to the compression. It must be glazed to overcome its porosity.

It has an excellent electrical insulation at room temperature (10^{11} ohms.m at 30°C), its insulation is still correct at 200°C (10^6 ohms.m), but its resistivity drops sharply to 300°C to be only 100 ohms.m at 600°C.

It is the oldest of the electrically insulating ceramic materials. It was traditionally used as early as the end of the 19th century to make electrical insulating parts for low-temperature domestic applications: Switches bases, lamp sockets, conductor supports, electrical terminal blocks. When enamelled, it is easy to clean.

The molds are simple, and easy to produce with rudimentary equipment. But if it is perfectly suitable for use up to 200°C, its use becomes hazardous above because of the rapid loss of its insulating properties. Expensive in manual manufacturing time, difficult to automate, it is still used in low salary-price countries.

The dimensional tolerances are wide, and the rate of rejects per crack due to unequal compression is important.

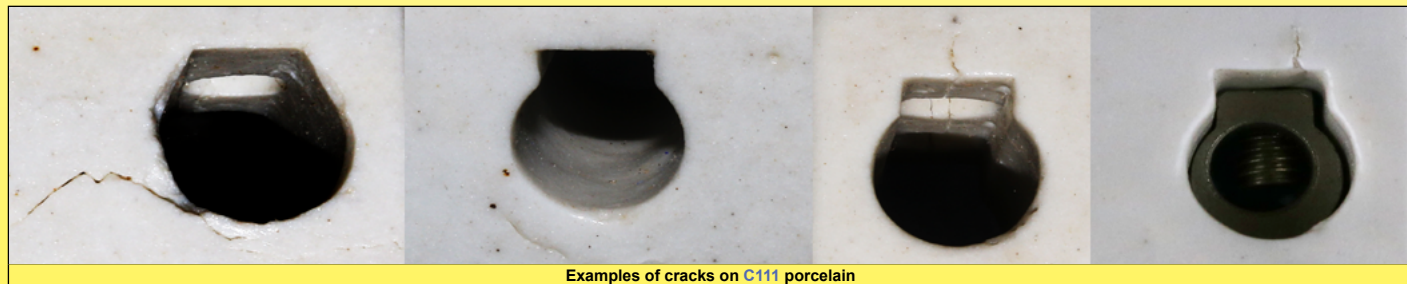

Examples of cracks on C111 porcelain

C110 Porcelain: This is a plasticized porcelain which can be injection molded. Its dielectric strength is excellent, of the order of 20KV/mm. As it is non-porous, it does not need to be enamelled except for reasons of ease of cleaning.

Its insulating characteristics in temperature are the same as the C111, that is to say 10^{10} ohms.m at 30°C, 10^6 at 200°C, and as well, the resistivity drops brutally towards 300°C to reach 100 ohms at 600°C.

The steatites of the C200 group

Steatites are distinguished from porcelain by their high percentage of magnesium oxide (MgO), of about 26 to 32%, the remainder being mainly silica (SiO₂) and fluxes. It is a material with a strong dielectric, highly insulating at high temperature, and it remains stable up to more than 1000°C.

Typical production processes are dry pressing, extrusion, casting and semi wet pressing. It is also molded by injection, in plastified form, and allows tight tolerances.

The material is fired at around 1400°C and steatite is formed by crystallization, fusion and dissolving during the vitrification. To obtain a contamination free and easy to clean surface, steatite can also be glazed.

Steatite C210 so-called low frequency steatite, is little used in electrothermal terminal blocks. It is obtained by semi-wet pressing and must be enamelled because its porosity is of the order of 0.7%. It retains good insulating properties even at 600°C (1000 ohms.m).

The Steatite C220, also called normal steatite, with zero porosity, is a steatite comprising 1 to 2% of Na₂O and 3 to 6% of alumina and flux. Like C210, its resistivity is 10^{10} ohms.m at 30°C, 10^7 ohms.m at 200°C and 10^3 ohms.m at 600°C.

The steatite C221, also known as high-frequency steatite, has zero porosity and differs from C220 by adding 7% Barium oxide (BaO). Highly insulating at room temperature (10^{11} ohms.m), it has the best resistivity at 600°C: 100000 ohms.m, **a thousand times more than porcelain**. It can be injection molded, with high precision. It is therefore the ideal material for terminal blocks that must withstand high or very high temperatures. It can be used raw or enamelled if appears the need for a smooth surface.

Technical introduction of connection blocks made in ceramic and polyamide



Because of permanent improvement of our products, drawings, descriptions, features used on these data sheets are for guidance only and can be modified without prior advice

The ceramics of the C600 group

The low alkali C610 aluminous ceramic, also known as Mullite, has a high percentage of alumina (Al₂O₃), of about 60% and the remainder of silica (SiO₂). Its porosity is zero. Its temperature resistivity and good, including up to 600°C (10000 ohms.m). Its good resistance to thermal shocks, its high mechanical resistance, its low coefficient of expansion and its good resistance to thermal shock, make it preferable for the realization of insulators of heating resistors, as well as for the protection tubes of the temperature sensors. Because of molding difficulties, it is not used in connection blocks.

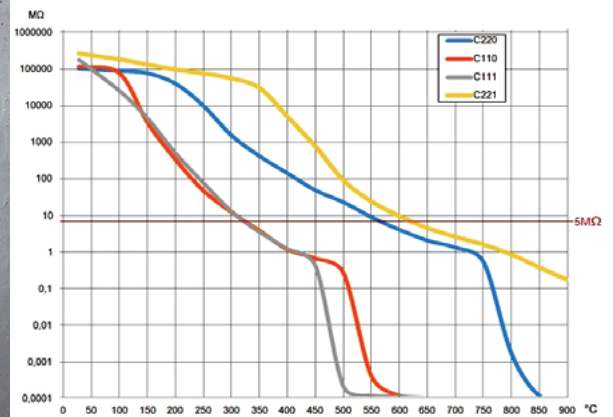
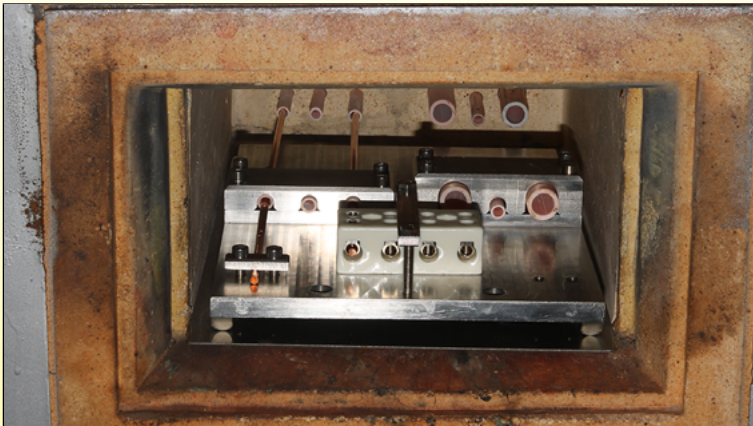

Test oven for the resistivity of ceramics as a function of temperature (Ultimheat Laboratory)

Insulation resistance variation curves of terminal blocks as a function of temperature, made in different types of ceramic, (C110, C111, C220, C221), in thickness 2mm. The value of 5MΩ is the normative limit.

Maximum temperature of ceramic in terminal blocks

Electrotechnical ceramics have very high temperatures with temperatures up to 1400°C, 1700°C or even higher. However, in electrical terminal block and insulator applications, the critical parameter is insulation resistance. IEC 60998 provides a **minimum insulation resistance of 5 MΩ** between live parts and between live parts and earth-contactable parts, such as a mounting plate. This isolation resistance depends on:

- the thickness of the insulation where it is the weakest.
- the temperature.

The design of our ceramic terminal blocks provides, where this thickness is the weakest, that is to say between the fixing screws and the electrical terminals:

- **minimum** 1.2mm wall thickness for terminal blocks up to 250V.
- **minimum** 2mm wall thickness for terminal blocks up to 450V.
- **minimum** 3mm wall thickness for terminal blocks up to 750V.

Given these values, and depending on the resistivity variation of ceramics as a function of temperature, the limit values **we recommend** are:

- For ceramic C111: 250°C
- For ceramic C110: 300°C
- For C220 steatite: 550°C
- For C221 steatite: 650°C

Limit values have been safely selected to be 100°C below the threshold of 5 MΩ (for a 2mm thickness wall).

Electrical and mechanical characteristics of plastics used in connection blocks

The plastic material of this terminal block, a particular high-end PA66, has been selected to meet the specific constraints of its use. The most critical constraint that a terminal block can undergo, is a poor tightening of a conductor, the high contact resistance of which causes the terminal to overheat and to melt the plastic material of the support. The class providing the highest resistance to overheating and that of plastics with a GWFI (Glow Wire Ignition Rating) greater than 850°C. **This class is mandatory for applications with unattended use**, according to the specifications of EN60335-1 § 30-2-3-1. The material we use for these terminal blocks has a **GWFI of 960°C**, well above the minimum specifications of this standard. This plastic also offers the best resistance to tracking currents with a CTI > 600 (Class 1, the highest).

Another critical parameter, for these housings intended for these connection blocks, designed for use in hot ambient temperature, is the temperature of deflection under load. Measured according to ISO 75, this plastic material has a particularly high deflection temperature of **282°C** under a 1.8 MPa load.

| Material | Heat deflection temperature under load according to ISO 75 | Flammability according to UL94 | Mechanical strength according to ISO 572-2 | Glow wire flammability index (GWFI), according to IEC 60695-2-12 |
|---|--|--|--|--|
| 25% Fiber glass reinforced PA66 (Black) | 282°C (1.8 Mpa) | UL94 VO and UL94-5V depending of thickness | 150 Mpa | 960°C |

Heat deflection temperature under load according to ISO 75-2

Determination of the temperature of deflexion under load upon ISO75-1 and 3, is an important parameter to judge of the ability of a plastic raw material to withstand a temperature rise without losing its mechanical strength. This value is requested by some appliances and commercial standards. To select the best material to use in plastic connection blocks, the tests have been made under 1.8 MPa load applied at the center of the 10mm width, on 80 x 10 x 4mm specimen (Method Af). The 4mm thickness has been selected as being, in the standard choice, the nearest value to the thickness used on connection blocks. The temperature rise is 2°C per minute. The final temperature is registered when the deflection has reached 0.34mm.

Technical introduction of connection blocks made in ceramic and polyamide



Because of permanent improvement of our products, drawings, descriptions, features used on these data sheets are for guidance only and can be modified without prior advice

Heat deflection temperature under load according to ISO 75

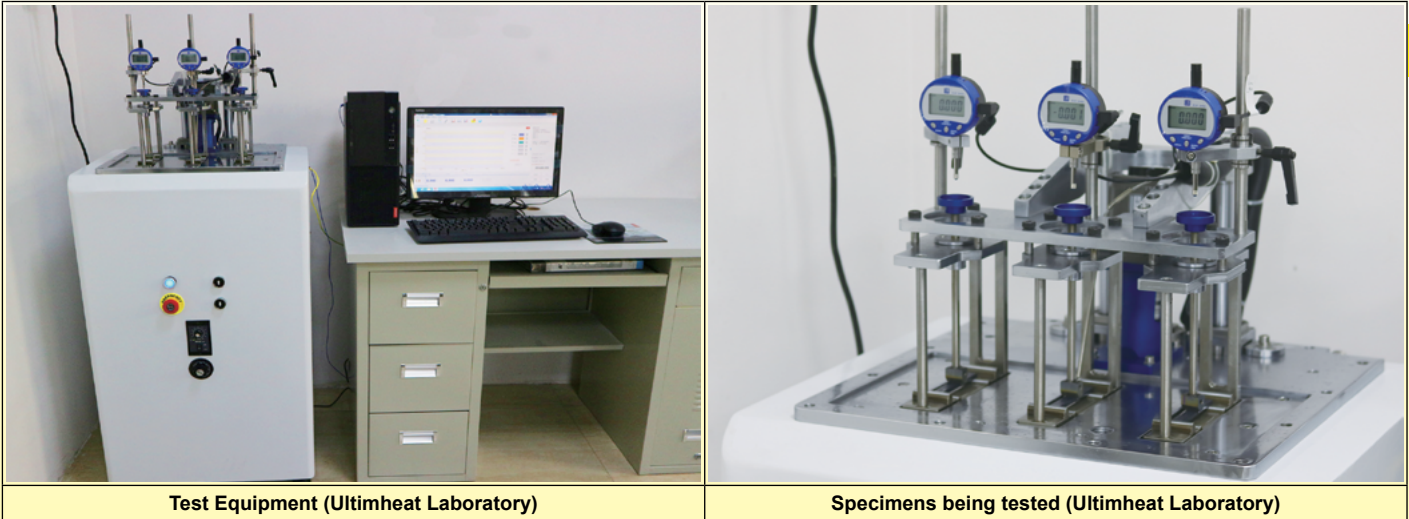

The maximum allowable temperature of PA66 connection blocks (the “T” marking)

The maximum permissible temperature on a terminal block is determined by the mechanical strength of the parts that support the terminals through which the current flows. For this it is considered that the terminals can heat up by Joule effect when they are crossed by the current. And this maximum heating value, required by standards EN60998 or EN60947 is 45°C in addition to the ambient temperature. This mechanical strength of the plastic material is measured by testing according to IEC 60695-10-2. This standard measures the penetration of a 5mm diameter ball under 20N force for one hour at the test temperature. The indentation made by the ball cannot exceed a diameter of 2mm. Consequently, a terminal block marked T200 ensures the good holding in place of parts through which the current flows when they are at a temperature of 200°C+45°C= 245°C.
 NB: For ceramic terminal blocks, this test is obviously not used, and it is the maximum temperature resistance of the metal parts that will define the resistance at room temperature.

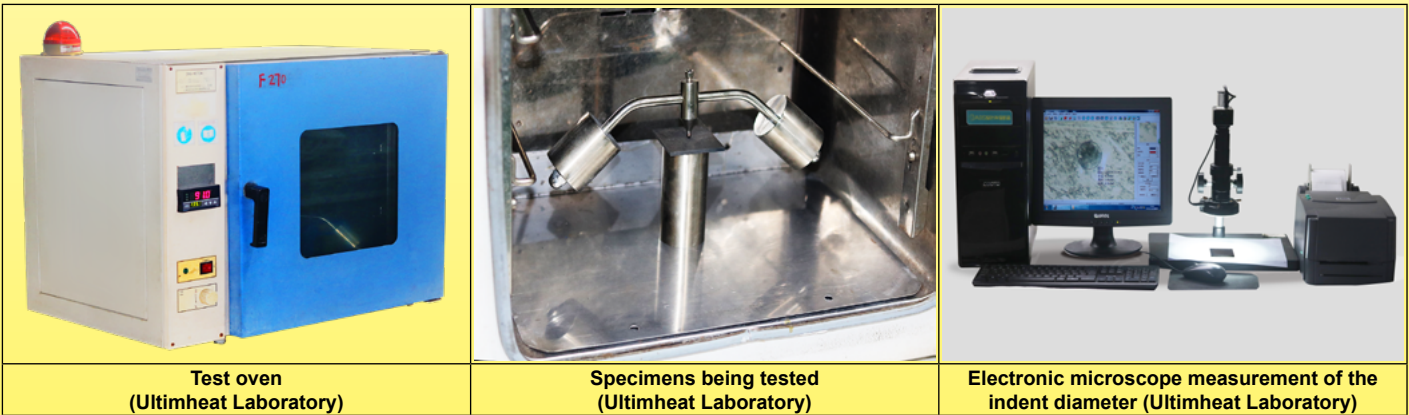

Flammability checking according to UL94, made in our laboratory





The flammability test of the plastics of the connection blocks is intended to verify that the accidental ignition of these will not spread and that the ignition will extinguish itself. The class usually required by certification laboratories is UL94-VO, or for some special cases, the highest class, UL94-5V.





Second section: Conductors and wires

Electric cable types according to the composition of their cores

| | | | |
|---|---|--|---|
|  |  |  |  |
| Class 1, solid core | Class 2, stranded core | Class 5, flexible core | Class 6, Ultra-flexible core |

The standard IEC 60228 (1978) divides the cores of electrical conductors into four main classes:

Class 1, solid core: the core is formed by a single wire, and is usually made in cross-section limited to 6 or 10 mm² maximum. This type of conductor is intended for fixed installations

Class 2, stranded core for fixed installations: used for cores with a cross section larger than 6 or 10 mm², the core is made up of several medium size wires. This type of conductor is intended for fixed installations

Class 5, flexible core: the core is made of many fine threads. This type of conductor is intended for connecting mobile equipment.

Class 6, Ultra-flexible core with greater flexibility than Class 5.

The terminals, depending on their nominal cross section, must accept the connection of conductors of classes 1, 2, 5, 6, unless different characteristics are given by the manufacturer.

Unless specifically marked, a terminal intended for a given maximum section must be capable of receiving solid or stranded conductors (classes 1 and 2) of this section, and flexible conductors (classes 5 and 6) of the section immediately below. For example, a 10mm² terminal block can receive a 10mm² conductor in class 1 or 2, and a 6mm² conductor class 5 or 6.

Correspondance of metric and AWG dimensions of electric conductors

To standardize the different existing standards defining sections of electrical conductors that have coexisted for decades, such as AWG, (also called Brown and Sharp), Birmingham, SWG (British Imperial Standard), Washburn & Moen etc., the international standard IEC60228 has defined the following cable gauges: 0.5 mm², 0.75 mm², 1 mm², 1.5 mm², 2.5 mm², 4 mm², 6 mm², 10 mm², 16 mm², 25mm², 35mm², 50mm²etc. ..., up to 1000mm². Terminal blocks in this catalog therefore refer to these values.

Exact equivalences in mm² of AWG wire gauges for solid wires

| AWG | Diameter (mm) | Cross section (mm ²) | AWG | Diameter (mm) | Cross section (mm ²) | AWG | Diameter (mm) | Cross section (mm ²) |
|-----|---------------|----------------------------------|-----|---------------|----------------------------------|-----|---------------|----------------------------------|
| 24 | 0.510 | 0.205 | 17 | 1.15 | 1.04 | 10 | 2.59 | 5.26 |
| 23 | 0.575 | 0.259 | 16 | 1.29 | 1.31 | 9 | 2.9 | 6.63 |
| 22 | 0.643 | 0.324 | 15 | 1.45 | 1.65 | 8 | 3.25 | 8.37 |
| 21 | 0.724 | 0.411 | 14 | 1.63 | 2.08 | 7 | 3.65 | 10.55 |
| 20 | 0.813 | 0.519 | 13 | 1.83 | 2.63 | 6 | 4.1 | 13.30 |
| 19 | 0.912 | 0.653 | 12 | 2.05 | 3.31 | 5 | 4.65 | 16.77 |
| 18 | 1.02 | 0.823 | 11 | 2.3 | 4.17 | 4 | 5.2 | 21.15 |

Standardized correspondence of cross-sections in mm² of metric electrical conductors with AWG sections

| The EN60998 standard gave equivalences for terminal clamping capacities between mm ² and AWG standards. | | | | | | | | | |
|--|-----|-----|----|----|----|----|----|----|----|
| mm ² | 1.5 | 2.5 | 4 | 6 | 10 | 16 | 25 | 35 | 50 |
| AWG | 16 | 14 | 12 | 10 | 8 | 6 | 4 | 2 | 0 |

Tightening torques in N.m for screw terminals according to EN60998 (for the models used in the terminal blocks of this catalog)

| | | | | | | |
|------|-----|------|-----|-----|-----|----|
| M2.6 | M3 | M3.5 | M4 | M5 | M6 | M8 |
| 0.4 | 0.5 | 0.8 | 1.2 | 2.0 | 2.5 | 4 |



Third part: The metallic parts of connection blocks

Electric terminal materials

The usual materials of the electric terminals are: brass, steel, stainless steel, nickel.

Their selection in a connection block is determined by three main factors:

- Resistance to electrical current flow "the resistivity", at different operating temperatures.
- The variation of the mechanical resistance as a function of the temperature, this is a critical parameter for terminal blocks operating high and very high temperature.
- The cost of the raw material and of its transformation.

Resistivity to the current

Any electrical terminal in which an electric current goes through is heated by the Joule effect. The larger the current section, the lower the resistance. The longer the length between the clamping screws of the conductors, the more resistance will increase. This logical rule is the basis of the design of the terminals. The second parameter is the resistivity, expressed in Ohms.m which is highly variable depending on the materials. The inverse of resistivity is conductivity, expressed in Siemens/m, which is also sometimes given in comparison to that of copper (in % of IACS). It can be noted that stainless steel has a conductivity more than 12 times lower than brass.

Another characteristic of these metals is an increase in their resistivity when the temperature rises. This parameter must be calculated carefully when designing the terminal cross-section when the operating temperature is high.

Table of resistivity and conductivity at 20°C of main metals used in connectors

| Units | Copper | Brass CuZn40Pb2 | Nickel | Steel | Stainless steel Aisi 304 |
|--|--------|-----------------|--------|-------|--------------------------|
| Resistivity ρ at 20°C, ($10^{-8} \Omega \cdot m$) | 1.67 | 7.1 | 8.7 | 14.3 | 73 |
| Conductivity σ , at 20°C, in 10^6 Siemens/m | 5.8 | 1.4 | 1.15 | 0.7 | 0.14 |
| Conductivity in % IACS (International Annealed Copper Standard.) | 100% | 24% | 20% | 18% | 2% |

Ultimate Tensile strength change versus temperature

Compared variations in ultimate tensile strength at break of copper, brass UZ34Pb2, SPCC cutting steel, stainless steel Aisi 304 and Nickel 201 according to the maximum exposure temperature maintained during 90 minutes (in% of the value measured at room temperature)

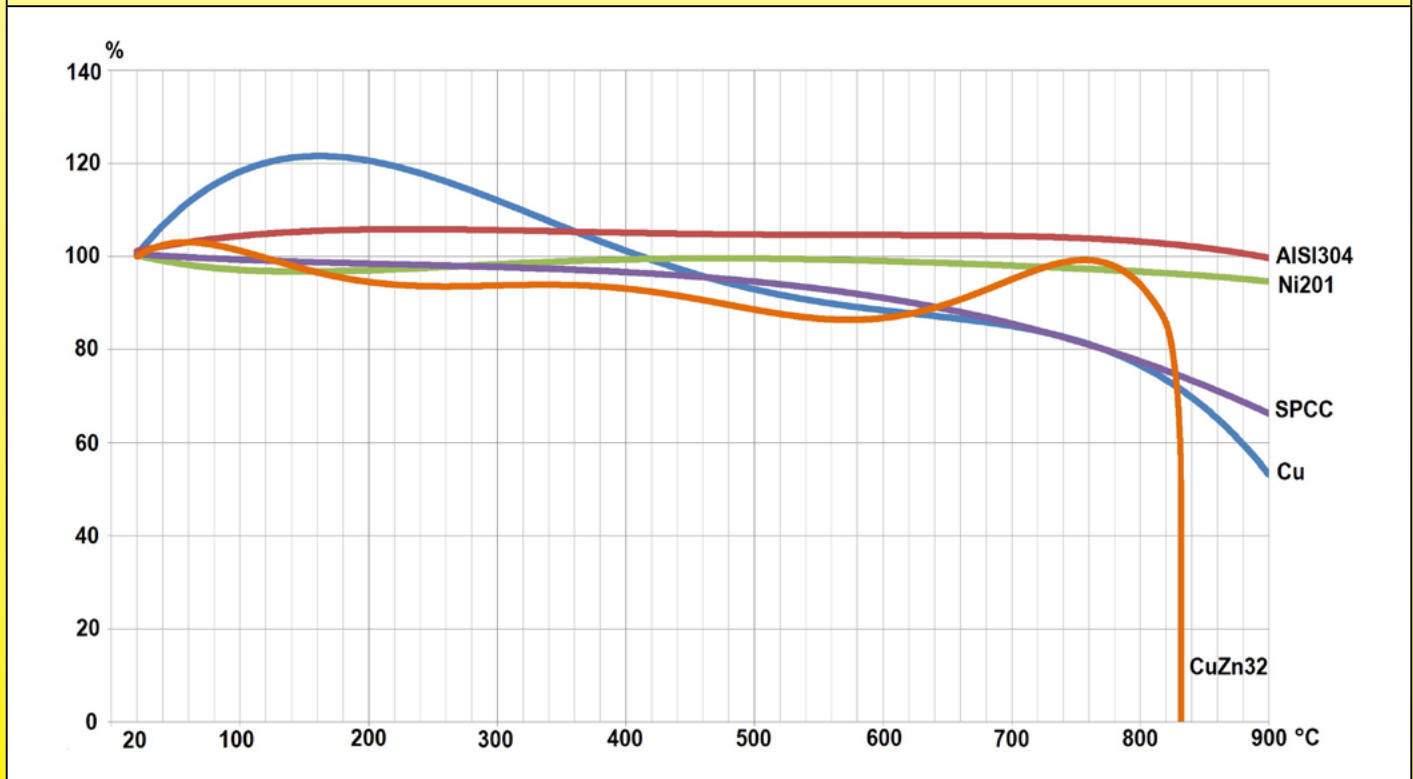

Copper and steel gradually lose their mechanical strength to retain only about 50% around 900°C. Brass remains relatively stable but reaches its melting point shortly before 900°C. 304 stainless steel and nickel 201 show no significant variation in their mechanical strength up to 900°C.

Because of permanent improvement of our products, drawings, descriptions, features used on these data sheets are for guidance only and can be modified without prior advice

Technical introduction of connection blocks made in ceramic and polyamide



The oxidation of metals according to the temperature

Appearance of specimens of brass, nickel-plated brass, nickel-plated steel, Aisi 304 and Nickel 201 after exposure for one hour at different temperatures, in an electric oven, under oxidizing atmosphere.

| Material | Exposure temperature | | | | | | | |
|--------------|----------------------|---------------|---------------|---------------|----------------|----------------|----------------|----------------|
| | 200°C / 392°F | 300°C / 572°F | 400°C / 752°F | 500°C / 932°F | 600°C / 1112°F | 700°C / 1292°F | 800°C / 1472°F | 900°C / 1652°F |
| Brass | | | | | | | | |
| Steel (SPCC) | | | | | | | | |
| Copper | | | | | | | | |
| Aisi 304 | | | | | | | | |
| Nickel 201 | | | | | | | | |

The oxide layers become unacceptable for copper and brass 400°C, or steel at 500°C, and for Aisi 304 stainless steel at 900°C. No appearance of significant oxide layer for Nickel 201

Cost of raw material (Compared to low carbon cold rolled steel type SPCC)

| 1 | x 3.9 | x 8.2 | x 38 |
|--|---------------------|-----------------|------------|
| Low carbon cold rolled steel type SPCC | 304 stainless steel | CuZn40Pb2 Brass | Nickel 201 |

Conductor clamping styles

| Wire termination styles | | Terminal style | | | | |
|---|-----------------|----------------------------------|-----------------|-------------------------------------|---|---------------------------|
| | | Screw with notched square washer | Direct screw | Screw with saddle and spring washer | Screw with saddle, spring washer and protective tab | Screw with pressure plate |
| Solid wire (class 1) | OK | OK | OK | OK | OK | |
| Stranded wire (class 2) | OK | OK | OK | OK | OK | |
| Flexible or very flexible wire (Class 5 or 6) | Acceptable | Not recommended | OK | OK | OK | |
| Tinned flexible wire end* | Not recommended | Not recommended | Not recommended | Not recommended | Not recommended | |
| Cable shoe | OK | OK | OK | OK | OK | |
| Spade terminal | OK | No | OK | OK | No | |
| Eyelet terminal | OK | No | OK | OK | No | |

* Clamping stranded or flexible conductors soldered together is not recommended because the tin alloy creeps.

Because of permanent improvement of our products, drawings, descriptions, features used on these data sheets are for guidance only and can be modified without prior advice

Technical introduction of connection blocks made in ceramic and polyamide



Because of permanent improvement of our products, drawings, descriptions, features used on these data sheets are for guidance only and can be modified without prior advice



Notched square washer screw terminals (Used mainly on PA66 connection blocks and on some ceramic connection blocks)

Depending on the size of the connection blocks, these terminals use M3, M3.5, M4, M5 and M6 screws. They feature:

- Manufacturing: very low weight of material used, very few manufacturing losses. It is therefore the most environmentally responsible terminal.
- The use of screws with a captive and enveloping square washer allows to put 2 wires inside each terminal, even with slightly different sizes without affecting the quality of tightening.
- The elastic effect of the washer also provides good resistance to loosening by vibration.
- This type of terminal allows the introduction of rigid or stranded conductors, fork lugs, eye lugs and cable shoe.
- The end of the terminal is not hidden, and makes possible to clearly visualize the correct introduction of the wires.
- The tightening of conductors, rigid or flexible is very effective, and their pull strength is significantly higher than the specifications of the standard.
- The conductive part of the terminal can be made of nickel-plated steel, raw or nickel-plated brass, pure nickel or even stainless steel.
- However, their small current passage section makes them very sensitive to Joule effect heating, especially when they are made of nickel-plated steel or stainless steel.



Extruded brass terminal with screw with direct clamping (only used on ceramic terminals)

This system is the most common, and has been used traditionally for more than 100 years on ceramic terminal blocks. These terminals are machined from specially extruded CUZn40Pb2 brass bars with the required profile for each dimension.

The composition of brass (60% copper) is important to ensure a low electrical resistivity, and to avoid the fragility of the material that appears with too high levels of zinc.

They have an extra thickness in the tapping in order to have sufficient thread length to withstand the tightening torques required by the standards, and the wall thickness around the central hole must also be sufficient to prevent the tube from cracking, when tightening the screw.

However, their manufacture in a metal other than brass (stainless steel, steel) is very difficult and expensive.

Because of the softening of brass at high temperatures, they cannot be used on high temperature terminal blocks.

Because of the weight of metal needed with this execution, they become very expensive for gauges above 16mm².

These terminals are also limited in the number of gauges of conductors that can be tightened effectively, because the stroke of the pressure screw is limited by the round section of the hole, the screw quickly becoming locked between the walls.



Stamped terminal with direct clamping screw (Used on ceramic terminal blocks with large sections or to withstand very high temperatures)

Unlike parts machined from a rod, this type of manufacturing, although expensive in tooling, reduces metal losses. It is particularly economical in large sections (Above 16mm²). It can also be used to make nickel-plated steel, stainless steel or nickel terminals. It is therefore the preferred technique for the realization of terminals resistant to temperatures up to 750°C. As the conductor hole is rectangular, the pressure screw has a longer clamping stroke and this increases the range of allowable gauges.



Stamped terminal with clamping screw and pressure plate (Used on ceramic terminal blocks with large sections or to withstand very high temperatures)

Reserved for large cross-section models, this system combines a stainless-steel body or nickel body, with stainless steel cylindrical socket head cap screws.

A nickel spring blade distributes the pressure. It is therefore recommended on flexible or extra-flexible conductors, of classes 5 and 6, because there is no risk of cutting the strands. The flexibility of the pressure plate maintains an optimal clamping independent of the expansions due to the temperature. These models support permanent temperatures of 750°C, and peak temperatures of 950°C



Screw with saddle and screw with saddle and protective tab (Used on ceramic connection blocks)

These terminals are used on high temperature terminal blocks because they are easily made of stainless steel. **They have the advantage of being able to put two conductors under the same saddle and to fit a large range of conductor gauges.** The spring washer located between the screw head and the saddle ensures the continuity of clamping, even at high temperatures and on copper conductors. However, due to the low electrical conductivity of stainless steel, the terminals tend to warm up much more than the brass or nickel terminals, which limits the maximum current they can withstand. If this limitation of the intensity is prohibitive it is recommended to use models with pure nickel terminals, but with elastic washer in stainless steel.

In order to avoid cutting the wire by shearing due to the saddle edge, it can incorporate an anti-shearing tab.

Technical introduction of connection blocks made in ceramic and polyamide



Because of permanent improvement of our products, drawings, descriptions, features used on these data sheets are for guidance only and can be modified without prior advice

Loosening terminal block screws due to temperature rise









On terminals that have to withstand high temperatures, the effect of temperature is a critical parameter that the applicable standards do not enough take into account. The most critical point is the loosening of the terminals, which by promoting the increase of the contact resistance between the terminal and the conductor, will cause a localized heating up to the ignition of nearby combustible materials. This loosening has four origins:

- The deformation of the terminal by its expansion, makes tightening looser. This deformation is generally reversible when the temperature drops, and can be compensated by the elasticity of the terminal or a spring included between the pressure screw and the conductor.
- The deformation of the terminal by the change of crystalline structure of the metal, similar to annealing. This deformation is in general irreversible
- Deformation of the copper conductor wire, made malleable by heat. This deformation is in general irreversible, but can be avoided by the use of conductors resistant to heat, for example nickel.
- The loosening of the pressure screw by the successive cycles of heating and cooling between different materials.

Two solutions that can be implemented separately or jointly exist.

1°: Insert an elastic metal part between the screw and the conductor;

2°: Set up a system of automatic locking of the screws caused by the deformation of the terminal during the tightening

| Average variation of the tightening torque of the terminal block screws after a short * peak of temperature. The tightening torque at 20°C is taken as 100% (The terminals are tightened on a steel rod with the maximum nominal diameter allowed for the terminal) | | | | | | | | | |
|---|---|---------------------|---------------------|---------------------|--|---------------------|-------------------------|-------------------------|-------------------------|
| Terminal style | Material | Température | | | | | | | |
| | | 90 minutes at 200°C | 90 minutes at 300°C | 90 minutes at 400°C | 90 minutes at 500°C | 90 minutes at 600°C | 90 minutes at 700°C | 90 minutes at 800°C | 90 minutes at 900°C |
|  | Full nickel plated steel | 93 | 82 | 80 | 91 | 87 | 72 | Screw blocked by oxide | Screw blocked by oxide |
|  | Full Stainless steel 304 | 96 | 93 | 81 | 80 | 80 | 85 | 86 | 84 |
|  | Nickel plated brass terminal, nickel plated steel screws | 84 | 84 | 74 | 66 | 50 | 36 | Terminal melted | Terminal melted |
|  | Brass terminal, nickel plated steel screws | 96 | 76 | 68 | 63 | 62 | 49 | Terminal melted | Terminal melted |
|  | Full Nickel plated steel | 91 | 77 | 77 | 77 | 51 | Screw blocked by oxide | Screw blocked by oxide | Screw blocked by oxide |
|  | Full stainless steel 304 | 95 | 91 | 81 | 78 | 80 | 86 | 88 | 84 |
|  | Nickel 201 terminal, 304 stainless steel screws | 95 | 91 | 81 | 78 | 80 | 86 | 88 | 84 |
|  | Nickel 201 terminal, nickel plated steel screws | 79 | 80 | 116 | 160 | 197 | 229 Screw is blocked | 255 Screw is blocked | 323 Screw is blocked |
|  | Nickel 201 terminal, 304 stainless steel screws with pressure plate | 100 | 170 | 103 | 103 | 104 | 108 | 145 | 170 |
| ≥ 25% or more loss of tightening | | | | | Terminals broken, or no more usable, or torque more than 2x higher than initial. | | | | |

Nickel-plated steel screws cannot be use, **even for short time**, at temperatures above 600°C, because the oxidation of the screw causes its blockage. For higher temperatures, only stainless steel or nickel screws are usable and remain functional, allowing disassembly and replacement if necessary.

Average variation of the tightening torque of the terminal block screws after an extended temperature exposure at 230°C. The tightening torque at 20°C is taken as 100% (The terminals are tightened on a steel rod with the maximum nominal diameter allowed for the terminal)

| Material | 230°C, 48H | 230°C, 120H | 230°C, 192H |
|---|------------|-------------|-------------|
| Nickel plated steel terminal with nickel plated steel screws | 81 | 120 | 111 |
| Brass terminal with nickel plated steel screws | 86 | 86 | 86 |
| Nickel-plated steel screws, used on steel or brass terminals, withstand 230°C in permanent temperature, without blockage and without abnormal oxidation | | | |

Average variation of the tightening torque of the terminal block screws after an extended temperature exposure at 300°C. The tightening torque at 20°C is taken as 100% (The terminals are tightened on a steel rod with the maximum nominal diameter allowed for the terminal)

| Material | 300°C, 48H | 300°C, 120H | 300°C, 192H |
|--|------------|-------------|-------------|
| Nickel plated steel terminal with nickel plated steel screws | 70 | 68 | 65 |
| Brass terminal with nickel plated steel screws | 62 | 60 | 60 |
| We do not recommend the use of nickel-plated steel screws on brass or nickel-plated steel terminals, for permanent temperatures above 300°C due to the loss of tightening torque | | | |

Technical introduction of connection blocks made in ceramic and polyamide



Wire pull-out force and vibration loosening resistance

Vibration resistance is an important parameter for terminal blocks, especially if they are installed on trucks, trains or near an engine. In order to verify the effectiveness of the accidental loosening resistance of the terminals, these were subjected to cycles of 10 minutes of variable sinusoidal vibrational sequences covering the range of 1.7 Hz to 5 Hz with variable accelerations from 0.3 to 2.6 G for 48 hours, and the pull-out forces were again measured.

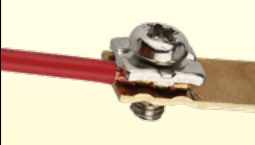
|  | | Stranded conductor with crimped cable shoe, on a brass terminal with a notched steel square washer | | | | | |
|--|-------------------------|--|---------------------|------------------|--------------------|--------------------|------------------|
| Type | Tightening torque (N.m) | 0.5mm ² | 0.75mm ² | 1mm ² | 1.5mm ² | 2.5mm ² | 4mm ² |
| M3 screw (before vibrations) | 0.50 | 65 | 105 | 134 | 151 | 211 | |
| M3 screw (after vibrations) | | 62 | 102 | 131 | 147 | 202 | |
| M3.5 screw (before vibrations) | 0.80 | 68 | 105 | 142 | 165 | 220 | |
| M3.5 screw (after vibrations) | | 65 | 102 | 132 | 162 | 218 | |
| M4 screw (before vibrations) | 1.20 | 86 | 110 | 145 | 157 | 235 | 260 |
| M4 screw (after vibrations) | | 84 | 107 | 138 | 153 | 231 | 248 |
| Minimum pull test values requested by EN60998 | | 20 | 30 | 35 | 40 | 50 | 60 |

Pull tests



Pull test bench



Jaws detail

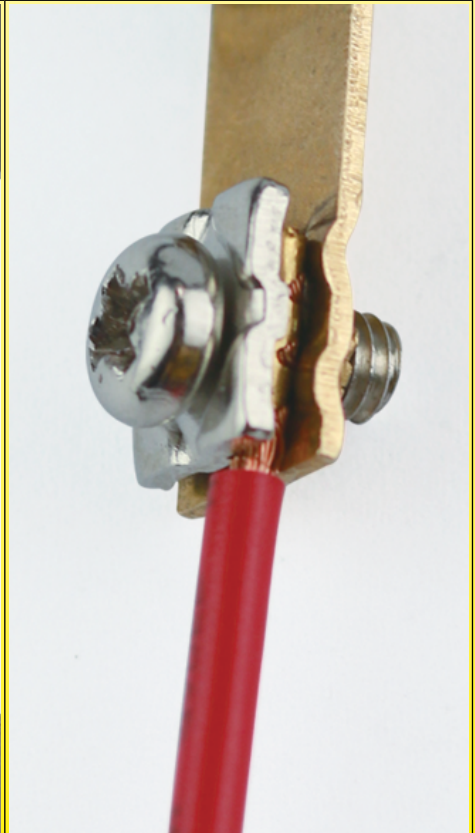

Terminal detail

Because of permanent improvement of our products, drawings, descriptions, features used on these data sheets are for guidance only and can be modified without prior advice

Technical introduction of connection blocks made in ceramic and polyamide



Because of permanent improvement of our products, drawings, descriptions, features used on these data sheets are for guidance only and can be modified without prior advice

Vibration resistance tests



Vibration test equipment

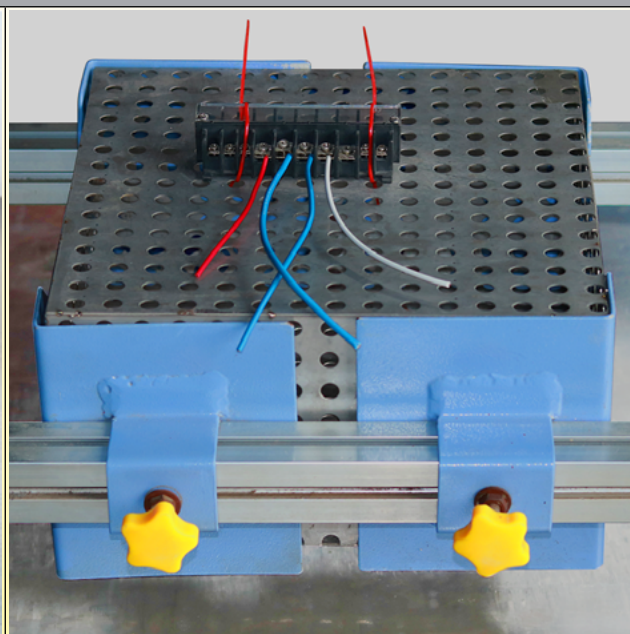

Connection block during test

Clearances and creepage distances

Creepage distances are measured by following the surface of the insulation, between two conductors of different polarity, or between a conductor and the ground. The minimum values of the creepage distances imposed by the standards depend, among other, on the operating voltage, the possible over-voltages on the network, and the specified application.

In the case of creepage measured on the surface of an insulator, the characteristics of the insulator used are important, because they will allow more or less easily the creation of electrical pathways, by forming conductive tracks. They are due to the superficial combustion by the electric current, in the presence of water of the plastic materials and the surface pollution of which the remaining carbon atoms become as many points of passage of the current. Plastics are therefore classified according to this feature.

It is called CTI (Comparative Tracking Index) in English and "Indice de Résistance au courant de Cheminement" (IRC) in French.

It is the maximum voltage, measured in volts, at which a material withstands 50 drops of contaminated water without tracking. Tracking is defined as the formation of conductive paths due to electrical stress, humidity, and contamination. The highest class of resistance to tracking currents is the 600V class, and therefore, this is the one that allows the smallest creepage distances. **The ceramic and PA66 used in the devices in this catalog both have a CTI 600.**

Clearances in air

The distances in the air (clearances), are the shortest distances measured in a direct line in the air between two conductors of a different voltage, or a conductor and the ground. They are representative of the path that would take an electric arc in the air during an overvoltage.

RoHS and REACH

RoHS : the materials used in the connection blocks comply with the European directive 2015/863 Annex II amending Directive 2011/65.

Certificates made by an accredited external laboratory available on request.

Reach: The materials used in the connection blocks comply with the REACH European Directives according to the June 2017 directive adding 173 substances SVHC (Substances of Very High Concern) from the list published by ECHA on 12 January 2017, applying to the directive Reach 1907/2006.

Certificates made by an accredited external laboratory available on request.

With or without halogens

According to the International Electrochemical Commission (IEC Standard 61249-2-21: Restricted use of halogen, intended for electronic circuits), to be classified in the "Halogen-free" category, a substance must contain less than 900 ppm of chlorine or bromine and contain less than 1,500 ppm of halogens. Halogen elements are any of the six non-metallic elements that constitute Group 17 (Group VIIa) of the periodic table. They are fluorine (F), chlorine (Cl), bromine (Br), iodine (I), and the rare and recently discovered astatine (At), and tennessine (Ts). The most common are chlorine and fluorine found in PVC and Teflon and its derivatives, and Bromine, used as a flame retardant additive in plastics. These products have the disadvantage of releasing toxic fumes when they catch fire. In addition to the risks to people, they also release corrosive gases harmful to electrical and electronic equipment. Among the flame retardants used in plastics, polychlorinated biphenyls (PCBs) and polybrominated biphenyls (PBBs) have an adverse effect on the environment and people due to their persistence, toxicity and ability to bioaccumulate.

Brominated flame retardants (BFRs) BFRs could form halogenated dioxins and furans when subjected to extreme thermal stress, which might occur during a fire.

PBBs and PBDEs (polybrominated diphenylethers), are now prohibited by the WEEE and RoHS Directives in Europe.

The PA66 plastic used in the connection blocks of this catalogue is halogen free, and complies with the existing standard in Europe



Because of permanent improvement of our products, drawings, descriptions, features used on these data sheets are for guidance only and can be modified without prior advice

List of references



Because of permanent improvement of our products, drawings, descriptions, features used on these data sheets are for guidance only and can be modified without prior advice

List of references



Because of permanent improvement of our products, drawings, descriptions, features used on these data sheets are for guidance only and can be modified without prior advice

| References |
|----------------|
| 66AT410650 |
| BJ06200000 |
| BJ06300000 |
| BJ0620000S |
| BJ0630000S |
| BJ06200004 |
| BJ06300004 |
| BJ0620000N |
| BJ0630000N |
| BJ062P00000 |
| BJ063P00000 |
| BJ062P0000S |
| BJ063P0000S |
| BJ062P00004 |
| BJ063P00004 |
| BJ062P0000N |
| BJ063P0000N |
| 66AT410650 |
| 66AJB42215 |
| 66AJB42218 |
| 66AJB52220 |
| 66AJB52223 |
| 66AJB62225 |
| 66AJB62228 |
| 66AJB82235 |
| BZM101206009GE |
| BZM101206009G4 |
| BZM161510009GE |
| BZM161510009G4 |
| BH43222650 |

| References |
|--------------------|
| BH59223250 |
| BH59224250 |
| BH70223250 |
| BH70224250 |
| BH80304250 |
| 66ABB0831169040B |
| 66ABC0831169040B |
| 66ABS0831169040B |
| 66ADB0841169040C |
| 66ADC0831169040C |
| 66ADS0831169040C |
| 66ACB0831169040D |
| 66ACC0831169040D |
| 66ACS0831169040D |
| 66ACB08CE470142D |
| 66ACC08CE470142D |
| 66ACS08CE470142D |
| 66AE40841197006B |
| 66AES0841197006B |
| 66AG4084116397006C |
| 66AGS084116397006C |
| 66AF40841197006D |
| 66AFS0841197006D |
| 66AS412501A1014A |
| 66AR412501A1024A |
| 66AJB0832293041B |
| 66AJB0832393042B |
| 66AJ420422B0043B |
| 66AJ420423B0044B |

Update 2023/11/30



Because of permanent improvement of our products, drawings, descriptions, features used on these data sheets are for guidance only and can be modified without prior advice



Because of permanent improvement of our products, drawings, descriptions, features used on these data sheets are for guidance only and can be modified without prior advice

Ceramic connection blocks



Because of permanent improvement of our products, drawings, descriptions, features used on these data sheets are for guidance only and can be modified without prior advice



Type BA

Main features

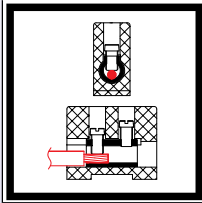

C221
unglazed
ceramic



Applications: These high-quality and small foot-print terminal blocks allow efficient and easy wiring of halogen lamps, heating elements, infrared heaters and quartz tube heaters. Because of their construction, they are non-flammable and resistant to temperature and humidity without losing their electrical and insulating characteristics.

They are built according to the specifications of IEC 60998-1 and IEC 60998-2, for a maximum voltage of **250V**.

Ceramic: Steatite type C221, unglazed, slightly creamy color.

Typical insulation between two terminals (500V measuring voltage):

- at 20°C (70°F): 300 MΩ
- at 100°C (212°F): 150 MΩ
- at 200°C (390°F): 110 MΩ
- at 300°C (570°F): 90 MΩ
- at 400°C (750°F): 60 MΩ

The insulation values with respect to the earth are approximately 2 times greater. The EN 60998 standard imposes an insulation resistance greater than 5 MΩ. Their insulating characteristics are therefore about 10 to 12 times higher, including at 400°C (750°F).

Dielectric strength: higher than **3000V**. Minimum distance through ceramic insulation between 2 terminals: **1.2mm**.

Screw: Galvanized steel 4.8, reduced diameter slotted cylindrical head, according to DIN 920

Terminals: CuZn40Pb2 brass, high mechanical strength. Models with nickel plated brass terminals are available on request (MOQ apply)

Maximum operating voltage: **250V**, in pollution class 3. (Pollution class 3 defines micro-environmental conditions causing conductive pollution or non-conductive pollution that may become conductive if condensation can occur).

Clearances and creepage distances: \geq **3mm** between mounting face and terminals, between terminals, and between two connection blocks mounted side by side.

Live parts: Protected against accidental electrical contact (Standard Finger Type A according to IEC 61032).

Mounting: With the exception of the single-wire terminals, the terminal blocks have one or two holes for installing them with a screw on a wall or a board. A hexagonal recess makes it possible to place a round-headed or hexagonal-headed screw, or a nut. This allows mounting with clamping by the front or the back.

Maximum ambient temperature:

- Permanent: 230°C / 450°F
- Peak (duration <90 minutes): 450°C / 840°F

The temperature resistance values of the brass connectors were validated by pull tests of the wires according to EN 60998, carried out after 48H at 230°C (450°F) or 90 minutes at 450°C (840°F).

Applicable standards: (IEC) EN 60998-1; (IEC) EN 60998-2-1

Attention: Special care must be taken to avoid reducing the insulation and safety distances from electric shock during installation: avoid the use of inappropriate mounting screws, respect wire stripping lengths and insert wires inside the terminal until the insulation comes into contact with the brass.

Steatite connection blocks 250V range



Protected against accidental electric contact, brass terminals, nickel plated steel screws.

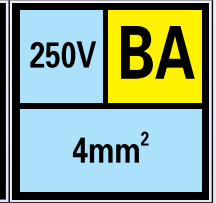
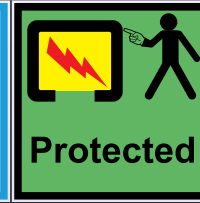
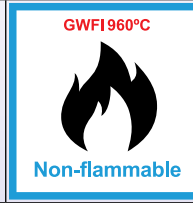
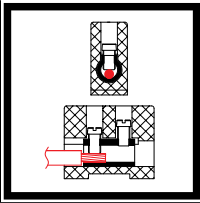

4 mm²

| | | |
|-----------------------------------|---|-----------------------------------|
| <p>BA041</p> <p>6 gr.</p> | <p>SOLID CONDUCTOR</p> <p>5.5-6.5 mm</p> <p>4mm² / 2.5mm² / 1.5mm² AWG 12 / AWG14 / AWG16</p> <p>STRANDED CONDUCTOR</p> <p>5.5-6.5 mm</p> <p>4mm² / 2.5mm² / 1.5mm² AWG 12 / AWG14 / AWG16</p> <p>0.4 N.m</p> <p>M2.6</p> | <p>BA042</p> <p>11 gr.</p> |
| <p>BA043</p> <p>17 gr.</p> | <p>SOLID CONDUCTOR</p> <p>5.5-6.5 mm</p> <p>4mm² / 2.5mm² / 1.5mm² AWG 12 / AWG14 / AWG16</p> <p>STRANDED CONDUCTOR</p> <p>5.5-6.5 mm</p> <p>4mm² / 2.5mm² / 1.5mm² AWG 12 / AWG14 / AWG16</p> <p>0.4 N.m</p> <p>M2.6</p> | <p>BA044</p> <p>23 gr.</p> |

Because of permanent improvement of our products, drawings, descriptions, features used on these data sheets are for guidance only and can be modified without prior advice



Type BU

Main features

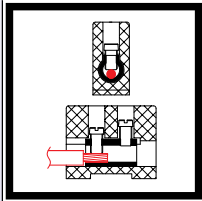

**C221
unglazed
ceramic**



Applications: These high-quality terminal blocks allow efficient and easy wiring of halogen lamps, heating elements, infrared heaters, quartz tube heaters, as well as for the wiring of ovens, and professional catering and cooking equipment. Thanks to their construction, they are non-flammable and resistant to temperature and humidity without losing their electrical and insulating characteristics.

They are built according to the specifications of IEC 60998-1 and IEC 60998-2, for a maximum voltage of 450V.

Ceramic: Steatite type C221, unglazed, slightly creamy color.

Typical insulation resistance between two terminals (500V measuring voltage):

at 20°C (70°F): 300 MΩ

at 100°C (212°F): 250 MΩ

at 200°C (390°F): 200 MΩ

at 300°C (570°F): 190 MΩ

at 400°C (750°F): 190 MΩ

The insulation values with respect to the earth are approximately 2 times greater. The EN 60998 standard imposes an insulation resistance greater than 5 MΩ. Their insulating characteristics are therefore about 20 to 40 times higher, including at 400°C (750°F).

Dielectric strength: higher than **4500V**. Minimum insulation distance through ceramic between 2 terminals: **2mm**

Screws: Galvanized steel 4.8, reduced diameter slotted cylindrical head, according to DIN 920

Terminals: CuZn40Pb2 brass, high mechanical strength. Models with nickel plated brass terminals are available on request (MOQ apply)

Maximum operating voltage: **450V**, in pollution class 3. (Pollution class 3 defines micro-environmental conditions causing conductive pollution or non-conductive pollution that may become conductive if condensation occurs).

Insulation distances: Greater than 4mm between mounting face and terminals, between terminals, and between two connection blocks mounted side by side.

Live parts: Protected against accidental electrical contact (Standard Finger Type A according to IEC 61032).

Mounting: With the exception of the single-wire terminals, the terminal blocks have one or two holes for installing them with a screw on a wall or a board. A hexagonal recess makes it possible to place a round-headed or hexagonal-headed screw, or a nut. This allows mounting with clamping by the front or the back.

Maximum ambient temperature:

- Permanent: 230°C / 450°F

- Peak (duration <90 minutes): 450°C / 840°F

The temperature resistance values of the brass connector were validated by pull tests of the wires according to EN 60998, carried out after 48H at 230°C (450°F) or 90 minutes at 450°C (840°F).

Applicable standards: (IEC) EN 60998-1; (IEC) EN 60998-2-1

Attention: Special care must be taken to avoid reducing the insulation and safety distances from electric shock during installation: avoid the use of inappropriate mounting screws, respect wire stripping lengths and insert wires inside the terminal until the insulation comes into contact with the brass.

Steatite connection blocks 450V range



Protected against accidental electric contact,
brass terminals, nickel plated steel screws.

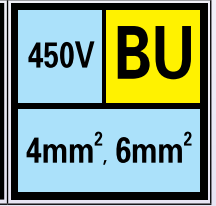
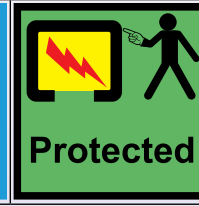
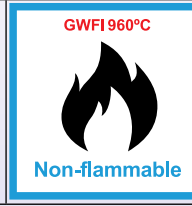
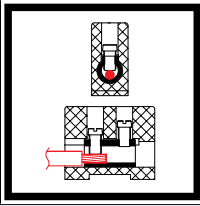

4mm²

| | | | | |
|--------------|-------|--|--------------|--------|
| BU041 | 7 gr. | SOLID CONDUCTOR 4mm ² / 2.5mm ² / 1.5mm ² AWG12 / AWG14 / AWG16 | BU042 | 13 gr. |
| | | | | |
| | | STRANDED CONDUCTOR 4mm ² / 2.5mm ² / 1.5mm ² AWG12 / AWG14 / AWG16 | | |
| | | 0.4 N.m | M2.6 | |
| | | 450V | 32A | |
| | | Permanent 230°C / 450°F Peak 450°C / 840°F | | |

6mm²

| | | | | |
|--------------|-------|---|--------------|--------|
| BU061 | 9 gr. | SOLID CONDUCTOR 6mm ² / 4mm ² / 2.5mm ² AWG10 / AWG12 / AWG14 | BU062 | 15 gr. |
| | | | | |
| | | STRANDED CONDUCTOR 4mm ² / 2.5mm ² AWG12 / AWG14 | | |
| | | 0.5 N.m | M3 | |
| | | 450V | 41A | |
| | | Permanent 230°C / 450°F Peak 450°C / 840°F | | |

Steatite connection blocks 450V range



Because of permanent improvement of our products, drawings, descriptions, features used on these data sheets are for guidance only and can be modified without prior advice



**Protected against accidental electric contact,
brass terminals, nickel plated steel screws.**

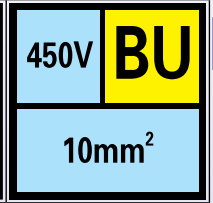
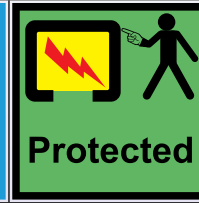
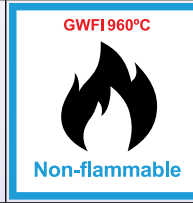
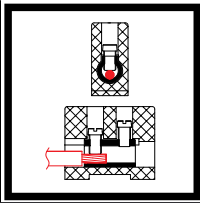

10mm²

| | | | | | | | |
|--------------|--|---------------|--|--|--------------|--|---------------|
| BU101 | | 13 gr. | SOLID CONDUCTOR | | BU102 | | 26 gr. |
| | | | <p>10mm² / 6mm² / 4mm² AWG8 / AWG10 / AWG12</p> | | | | |
| | | | STRANDED CONDUCTOR | | | | |
| | | | <p>6mm² / 4mm² AWG10 / AWG12</p> | | | | |
| BU103 | | 42 gr. | BU104 | | | | 51 gr. |
| | | | <p>0.8 N.m M3.5</p> | | | | |
| | | | <p>450V 57A</p> | | | | |
| | | | <p>Permanent 230°C / 450°F</p> <p>Peak 450°C / 840°F</p> | | | | |

Steatite connection blocks 450V range



Protected against accidental electric contact, brass terminals, nickel plated steel screws.

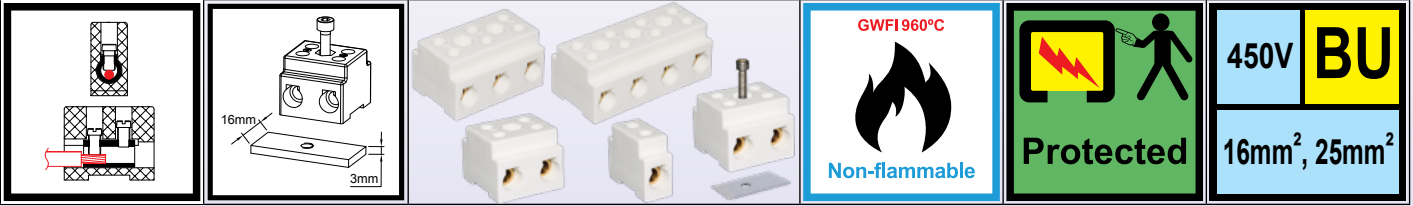

16mm²

Mounting on 16x3mm rail is possible

| | | | | |
|--------------|--------|---|--------------|---------|
| BU161 | 27 gr. | SOLID CONDUCTOR | BU162 | 58 gr. |
| | | 7-9.5 mm 16mm ² / 10mm ² / 6mm ² AWG6 / AWG8 / AWG10 | | |
| | 81 gr. | 1.2 N.m 450V Permanent 230°C / 450°F Peak 450°C / 840°F | | 103 gr. |

25mm²

Mounting on 16x3mm rail is possible

| | | | | |
|--------------|---------|---|--------------|---------|
| BU251 | 45 gr. | SOLID CONDUCTOR | BU252 | 85 gr. |
| | | 7.5-9.5 mm 25mm ² / 16mm ² / 10mm ² AWG4 / AWG6 / AWG8 | | |
| | 132 gr. | 2 N.m 450V Permanent 230°C / 450°F Peak 450°C / 840°F | | 180 gr. |

Because of permanent improvement of our products, drawings, descriptions, features used on these data sheets are for guidance only and can be modified without prior advice

Steatite connection blocks 450V range. Protected against accidental electric contact, stamped brass terminals, nickel plated steel screws.

Type BL

Main features

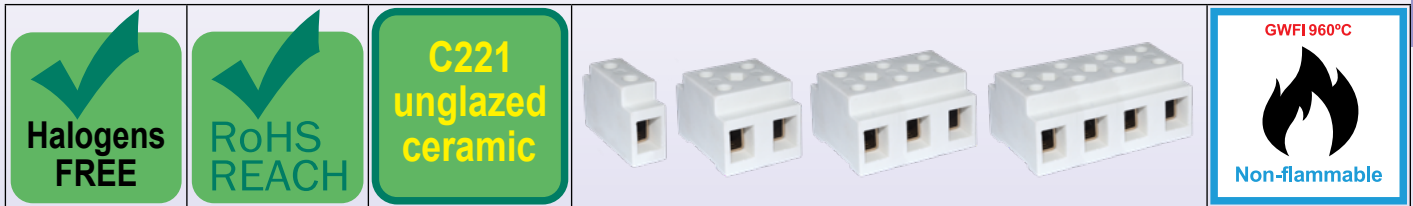

Applications: The BL series differs from the BU series by its terminals, which are **stamped brass and not machined from rod**. This configuration, which allows rectangular holes for the passage of conductors, also allows to admit a wider range of cross-sections, while providing a significant economy of material. This series has versions with direct pressure screws and indirect clamping by stainless steel pressure plate, **more suitable for flexible and extra-flexible conductors**.

These terminal blocks allow efficient and easy wiring of halogen lamps, heating elements, infrared heaters, quartz tube heaters, as well as for the wiring of ovens and professional catering and cooking equipment. Because of their construction, they are non-flammable and resistant to temperature and humidity without losing their electrical and insulating characteristics.

They are built according to the specifications of IEC 60998-1 and IEC 60998-2, for a maximum voltage of 450V.

Ceramic: Steatite type C221, unglazed, slightly creamy color.

Typical insulation resistance between two terminals (500V measuring voltage):

at 20°C (70°F): 300 MΩ

at 100°C (212°F): 250 MΩ

at 200°C (390°F): 200 MΩ

at 300°C (570°F): 190 MΩ

at 400°C (750°F): 190 MΩ

The insulation values with respect to the earth are approximately 2 times greater. The EN 60998 standard imposes an insulation resistance greater than 5 MΩ. Their insulating characteristics are therefore about 20 to 40 times higher, including at 400°C (750°F).

Dielectric strength: higher than **3000V**. Minimum insulation distance through ceramic between 2 terminals: **2mm**

Screw: Galvanized steel 4.8, reduced diameter slotted cylindrical head, according to DIN 920

Terminals: CuZn40Pb2 brass, high mechanical strength. Models with nickel plated brass terminals are available on request (MOQ apply)

Maximum operating voltage: **450V**, in pollution class 3. (Pollution class 3 defines micro-environmental conditions causing conductive pollution or non-conductive pollution that may become conductive if condensation occurs).

Insulation distances: Greater than 4mm between mounting face and terminals, between terminals, and between two connection blocks mounted side by side.

Live parts: Protected against accidental electrical contact (Standard Finger Type A according to IEC 61032).

Mounting: With the exception of the single-wire terminals, the terminal blocks have one or two holes for installing them with a screw on a wall or a board. A hexagonal recess makes it possible to place a round-headed or hexagonal-headed screw, or a nut. This allows mounting with clamping by the front or the back.

Maximum ambient temperature:

- Permanent: 230°C / 450°F

- Peak (duration <90 minutes): 450°C / 840°F

The temperature resistance values of the brass connector were validated by pull tests of the wires according to EN 60998, carried out after 48H at 230°C (450°F) or 90 minutes at 450°C (840°F).

Options: Nickel plated steel terminals

Applicable standards: (IEC) EN 60998-1; (IEC) EN 60998-2-1

Attention: Special care must be taken to avoid reducing the insulation and safety distances from electric shock during installation: avoid the use of inappropriate mounting screws, respect wire stripping lengths and insert wires inside the terminal until the insulation comes into contact with the brass.

Steatite connection blocks 450V range



Protected against accidental electric contact, **stamped** brass terminals, nickel plated steel screws.

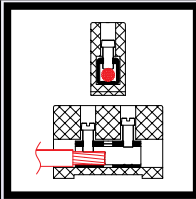

Without pressure plate

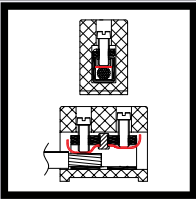

With pressure plate

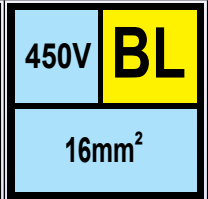
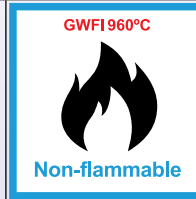
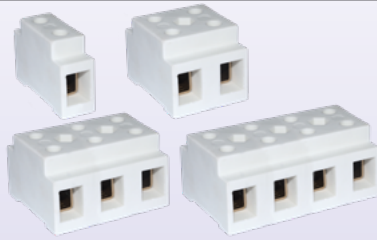

16 mm² direct pressure screw

Mounting on 35mm Din rail or 16 x 3mm rail is possible

| | | | | |
|--------------|---------|--|--------------|---------|
| BL161 | 49 gr. | SOLID CONDUCTOR | BL162 | 108 gr. |
| | | <p>16mm² / 10mm² / 6mm² AWG6 / AWG8 / AWG10</p> | | |
| BL163 | 167 gr. | STRANDED CONDUCTOR | BL164 | 226 gr. |
| | | <p>1.2 N.m M4</p> <p>450V 79A</p> <p>Permanent 230°C / 450°F</p> <p>Peak 450°C / 840°F</p> | | |

16 mm² indirect clamping screw, with pressure plate

Mounting on 35mm Din rail or 16 x 3mm rail is possible

| | | | | |
|---------------|---------|--|---------------|---------|
| BL161P | 100 gr. | SOLID CONDUCTOR | BL162P | 225 gr. |
| | | <p>16mm² / 10mm² / 6mm² AWG6 / AWG8 / AWG10</p> | | |
| BL163P | 350 gr. | STRANDED CONDUCTOR | BL164P | 475 gr. |
| | | <p>1.2 N.m M4</p> <p>450V 79A</p> <p>Permanent 230°C / 450°F</p> <p>Peak 450°C / 840°F</p> | | |

Because of permanent improvement of our products, drawings, descriptions, features used on these data sheets are for guidance only and can be modified without prior advice

Steatite connection blocks 450V range



Protected against accidental electric contact, **stamped** brass terminals, nickel plated steel screws.

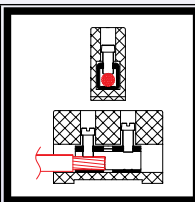

Without pressure plate

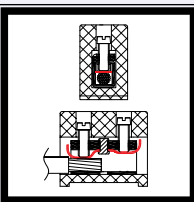

With pressure plate

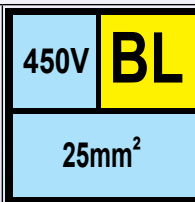
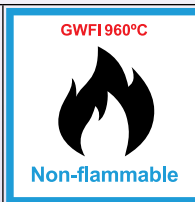
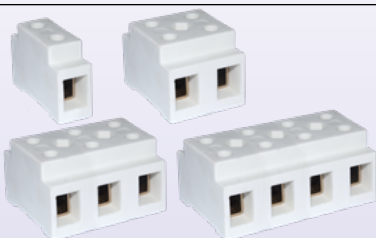

25 mm² direct pressure screw

Mounting on 35mm Din rail or 16 x 3mm rail is possible

| | | | | |
|--------------|--|---|--------------|---------|
| BL251 | 59 gr. | SOLID CONDUCTOR | BL252 | 133 gr. |
| | 8.5-12.5 mm 25mm ² / 16mm ² / 10mm ² AWG4 / AWG6 / AWG8 STRANDED CONDUCTOR 8.5-12.5 mm 16mm ² / 10mm ² AWG6 / AWG8 | | | |
| | 2 N.m 450V Permanent 230°C / 450°F Peak 450°C / 840°F | M5 101A Permanent 230°C / 450°F Peak 450°C / 840°F | BL254 | 280 gr. |

25 mm² indirect clamping screw, with pressure plate

Mounting on 35mm Din rail or 16 x 3mm rail is possible

| | | | | |
|---------------|--|---|---------------|---------|
| BL251P | 60 gr. | SOLID CONDUCTOR | BL252P | 135 gr. |
| | 8.5-12.5 mm 25mm ² / 16mm ² / 10mm ² AWG4 / AWG6 / AWG8 STRANDED CONDUCTOR 8.5-12.5 mm 16mm ² / 10mm ² AWG6 / AWG8 | | | |
| | 2 N.m 450V Permanent 230°C / 450°F Peak 450°C / 840°F | M5 101A Permanent 230°C / 450°F Peak 450°C / 840°F | BL254P | 285 gr. |

Because of permanent improvement of our products, drawings, descriptions, features used on these data sheets are for guidance only and can be modified without prior advice

Steatite connection blocks 450V range



Protected against accidental electric contact, **stamped** brass terminals, nickel plated steel screws.

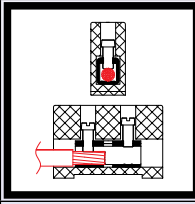

Without pressure plate

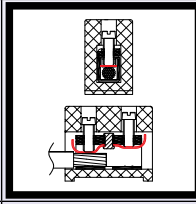

With pressure plate

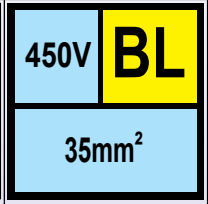
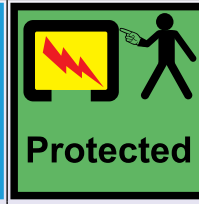
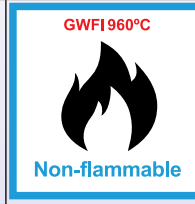
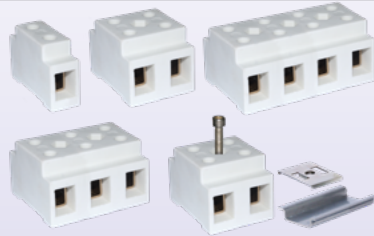

35 mm² direct pressure screw Mounting on 35mm Din rail is possible

| | | | | | |
|--------------|---------|--|---------------|--------------|---------|
| BL351 | 97 gr. | SOLID CONDUCTOR 35mm ² / 25mm ² / 16mm ² / 10mm ² AWG2 / AWG4 / AWG6 / AWG8 | BL352 | 219 gr. | |
| | | | | | |
| | | STRANDED CONDUCTOR 25mm ² / 16mm ² / 10mm ² AWG4 / AWG6 / AWG8 | | | |
| BL353 | 341 gr. | | | BL354 | 463 gr. |
| | | 2.5 N.m | M6 | | |
| | | 450V | 125A | | |
| | | Permanent | 230°C / 450°F | | |
| | | Peak | 450°C / 840°F | | |

35 mm² indirect clamping screw, with pressure plate Mounting on 35mm Din rail is possible

| | | | | | |
|---------------|---------|--|---------------|---------------|---------|
| BL351P | 100 gr. | SOLID CONDUCTOR 35mm ² / 25mm ² / 16mm ² / 10mm ² AWG2 / AWG4 / AWG6 / AWG8 | BL352P | 225 gr. | |
| | | | | | |
| | | STRANDED CONDUCTOR 25mm ² / 16mm ² / 10mm ² AWG4 / AWG6 / AWG8 | | | |
| BL353P | 350 gr. | | | BL354P | 475 gr. |
| | | 2.5 N.m | M6 | | |
| | | 450V | 125A | | |
| | | Permanent | 230°C / 450°F | | |
| | | Peak | 450°C / 840°F | | |

| | | |
|--|-----------------------------|------------|
| | 35mm Din rail mounting clip | Reference |
| | | 66AT410650 |

Because of permanent improvement of our products, drawings, descriptions, features used on these data sheets are for guidance only and can be modified without prior advice



Protected against accidental electric contact, stamped terminals, with **double entries** and double tightening, can be used as a very high temperature junction box

Type BJ

Main features

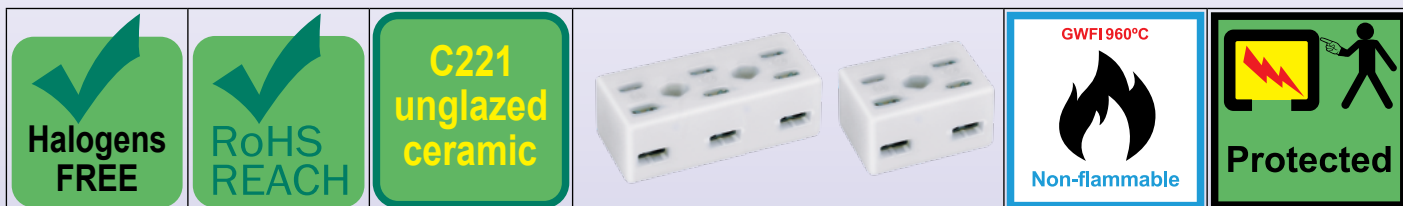

Main features: The BJ series differs from the BL series by its terminals, which are double input and double clamping. This configuration allows to **independently clamp two conductors per input**, while providing a significant economy of material.

They allow the simple connection of distribution cables for series-connected devices, such as lighting systems in road or rail tunnels, each terminal can at the same time ensure the continuity of the main line, and the diversion to one or two devices. Because of their construction, they are non-flammable and resistant to temperature and humidity without losing their electrical and insulating characteristics. Depending on the materials used for the manufacture of the terminals, they can withstand more or less prolonged fire conditions. This series includes versions with direct clamping or indirect clamping by screw on stainless steel pressure plate, **more suitable for flexible and extra-flexible cables**.

Ceramic: Steatite type C221, unglazed, slightly creamy color.

Typical insulation resistance between two terminals (500V measuring voltage):

at 20°C (70°F): 300 MΩ

at 100°C (212°F): 250 MΩ

at 200°C (390°F): 200 MΩ

at 300°C (570°F): 190 MΩ

at 400°C (750°F): 190 MΩ

The insulation values with respect to the earth are approximately 2 times greater. The EN 60998 standard imposes an insulation resistance greater than 5 MΩ. Their insulating characteristics are therefore about 20 to 40 times higher, including at 400°C (750°F).

Dielectric strength: higher than **3000V**. Minimum insulation distance through ceramic between 2 terminals: **2mm**

Maximum operating voltage: **450V**, in pollution class 3.

Insulation distances: Greater than **4mm** between mounting face and terminals, between terminals, and between two connection blocks mounted side by side.

Live parts: Protected against accidental electrical contact (Standard Finger Type A according to IEC 61032).

Mounting: they have one or two holes for installing them with a f screw on a wall or a board. A hexagonal recess makes it possible to place a round-headed or hexagonal-headed screw, or a nut. This allows mounting with clamping by the front or the back.

Applicable standards: (IEC) EN 60998-1; (IEC) EN 60998-2-1.

Because of permanent improvement of our products, drawings, descriptions, features used on these data sheets are for guidance only and can be modified without prior advice

Steatite connection blocks 450V range



Protected against accidental electric contact, stamped terminals, with **double entries** and double tightening, can be used as a very high temperature junction box

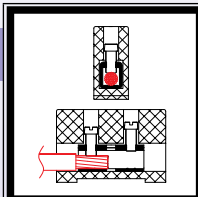

Without pressure plate

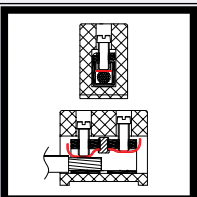

With pressure plate

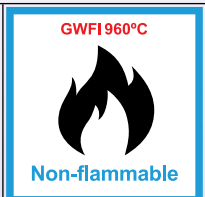

Non-flammable



Protected

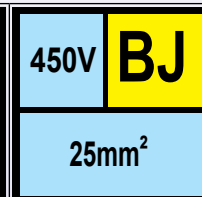

450V

BJ

25mm²

2 x 6 mm² direct pressure screw

| | | | | |
|---|---------------|--|--|-----------------|
| <p>BJ0620**** (Direct clamping)</p> <p>M3 8.8mm 19mm 4.5mm Ø4.3mm 35mm 24mm HEX 7.8mm JPCI BJ 062 450V</p> | <p>38 gr.</p> | <p>SOLID CONDUCTOR</p> <p>5-8 mm 2x6mm² / 2x4mm² / 2x2.5mm² 2xAWG10 / 2xAWG12 / 2xAWG14</p> <p>STRANDED CONDUCTOR</p> <p>5-8 mm 2x4mm² / 2x2.5mm² 2xAWG12 / 2xAWG14</p> | <p>BJ0630**** (Direct clamping)</p> <p>M3 20mm 8.8mm 19mm 4.5mm Ø4.3mm(X2) 55mm 24mm HEX 7.8mm(X2) JPCI BJ 063 450V</p> | <p>60 gr.</p> |
| <p>BJ062P**** (Clamping with Aisi 301 pressure plate)</p> <p>M3 8.8mm 19mm 4mm Ø4.3mm 35mm 24mm HEX 7.8mm JPCI BJ 062 450V</p> | <p>39 gr.</p> | <p>0.5 N.m (x2) 2 x M3</p> <p>450V 41A (x2)</p> | <p>BJ063P**** (Clamping with Aisi 301 pressure plate)</p> <p>M3 20mm 8.8mm 19mm 4mm Ø4.3mm(X2) 55mm 24mm HEX 7.8mm(X2) JPCI BJ 063 450V</p> | <p>61.5 gr.</p> |

Full references

| Type | Terminals Material | Permanent Temperature | Peak Temperature (90 min) | References with direct clamping | References with pressure plate |
|-------|----------------------------|-----------------------|---------------------------------|---------------------------------|--------------------------------|
| BJ062 | Un-plated brass* | 230°C/450°F | 450°C/840°F | BJ06200000 | BJ062P00000 |
| BJ063 | Un-plated brass* | 230°C/450°F | 450°C/840°F | BJ06300000 | BJ063P00000 |
| BJ062 | Nickel plated steel* | 400°C/750°F | 550°C/1020°F | BJ0620000S | BJ062P0000S |
| BJ063 | Nickel plated steel* | 400°C/750°F | 550°C/1020°F | BJ0630000S | BJ063P0000S |
| BJ062 | Aisi 304 Stainless steel** | 500°C/930°F | 700°C/1290°F 900°C/1650°F*** | BJ06200004 | BJ062P00004 |
| BJ063 | Aisi 304 Stainless steel** | 500°C/930°F | 700°C/1290°F 900°C/1650°F*** | BJ06300004 | BJ063P00004 |
| BJ062 | Nickel 201** | 500°C/930°F | 700°C/1290°F 950°C/1740°F*** | BJ0620000N | BJ062P0000N |
| BJ063 | Nickel 201** | 500°C/930°F | 700°C/1290°F 950°C/1740°F*** | BJ0630000N | BJ063P0000N |

* : Nickel plated steel screw.

** : Stainless steel screw.

*** : Conditions encountered in case of fire. The terminal block provides electrical continuity for about 2 hours at this temperature, but must be replaced later.

Because of permanent improvement of our products, drawings, descriptions, features used on these data sheets are for guidance only and can be modified without prior advice

Very high temperature steatite connection blocks. Indirect pressure clamping, with pressure plate, not protected against electric shocks, 750V range



Type BK

Main features

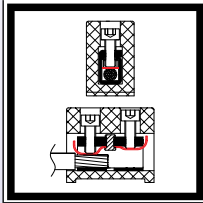

**C221
unglazed
ceramic**



Applications: These terminal blocks have been developed to meet the specific needs of connections that must withstand very high temperatures, up to **500°C (930°F) permanently and 700°C (1290°F) peak**. They also ensure the continuity of the connection in case of fire up to **950°C (1740°F)** (Their subsequent replacement is then necessary). They are particularly intended for **road tunnels, public transport tunnels (trains, subways), boat and submarine parts that must withstand a fire**, but also for furnace connections when the ambient temperature is very high at all times. Because of their construction, they are non-flammable and resistant to moisture. Although standards IEC (EN) 60998-1 and IEC (EN) 60998-2 have not provided for the special temperature holding conditions of these terminal blocks, their construction meets their specifications (where applicable), for a maximum voltage of **750V**.
At 700°C, in 230V, the leakage current to earth is about 0.1milliamperes. The IEC 60331-21 and IEC 60331-11 standards for fire resistance of cables require a maximum leakage current of 2A at 850°C. It is reached only around 900°C in these terminals, for a voltage of 230V.

Ceramic: Steatite type C221, unglazed, slightly creamy color.

Typical isolation resistors between two terminals (500V measuring voltage):

- at 20°C (70°F): > 100 GΩ
- at 100°C (212°F): > 100 GΩ
- at 200°C (390°F): 90 GΩ
- at 300°C (570°F): 55 GΩ
- at 400°C (750°F): 5 GΩ
- at 500°C (930°F): 90 MΩ
- at 600°C (1110°F): 10 MΩ
- at 700°C (1290°F): 2,5 MΩ

The EN 60998 standard imposes an insulation resistance greater than 5MΩ. It is reached around **680°C (1250°F)** on this model.

Dielectric strength: greater than **3000V** at 20°C

Screws: 304 stainless steel, hollow hexagonal head, according to ISO 4762

Terminals: **Nickel**

Pressure Plates: **Nickel**

Maximum operating voltage: **750V**, in pollution class 3. (Pollution class 3 defines micro environmental conditions causing conductive pollution, or when a non-conductive pollution that may become conductive if condensation occurs).

Insulation distances: Greater than **6mm** between mounting face and terminals, between terminals, and between two connection blocks mounted side by side.

Live parts: **Not protected against accidental electrical contact.**

Mounting: With the exception of the single-wire terminals, the terminal blocks have one or two holes for installing a fixing screw on a wall. A hexagonal housing makes it possible to place a round-headed or hexagonal screw, or a nut. This allows mounting with clamping by the front or the back. **The largest dimensions (35 and 50mm²) can accommodate a 35mm Din rail mounting clip.**

Important note: These terminal blocks must imperatively be fixed in order to prevent their movement for any reason in the box in which they are mounted, and consequently put them in a position where the insulation distances are no longer respected.

Maximum ambient temperature:

- Permanent: 500°C / 930°F
- Peak (<90 minutes): 700°C / 1290°F

The temperature resistance values of the nickel terminals were validated by wire pull tests according to EN 60998, performed after 48H at 500°C (930°F) and 90 minutes at 700°C (1290°F).

Partially applicable standards: (IEC) EN 60998-1; (IEC) EN 60998-2-1.

Caution: Special care must be taken to avoid electric shock. These terminal blocks are not usable in places accessible without tools. They must be mounted in protective boxes. Respect the distances in the air of at least **6mm** between the live parts and the walls of the protective case. Other rules may apply according to local safety regulations.

Very high temperature steatite connection blocks, 750V range



Not protected against accidental electric contact, nickel terminals, stainless steel screws, nickel pressure plate

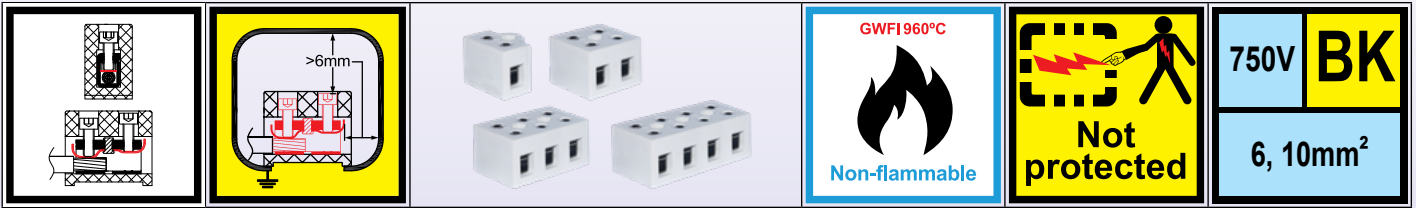

6mm²

| | | | | | | | | | | |
|----------------------|---|----------------------|-----------|-------------|------------|-----------|-------------|------|-------------------------------|--|
| BK061 46 gr. | SOLID CONDUCTOR 6.5-9.5mm 6mm ² / 4mm ² / 2.5mm ² AWG10 / AWG12 / AWG14 STRANDED CONDUCTOR 6.5-9.5mm 4mm ² / 2.5mm ² AWG12 / AWG14 | BK062 82 gr. | | | | | | | | |
| | <table border="1"> <tr> <td>0.5 N.m</td> <td>M3</td> </tr> <tr> <td>750V</td> <td>41A</td> </tr> <tr> <td>Permanent</td> <td>500°C/930°F</td> </tr> <tr> <td>Peak</td> <td>700°C/1290°F 950°C/1740°F*</td> </tr> </table> | 0.5 N.m | M3 | 750V | 41A | Permanent | 500°C/930°F | Peak | 700°C/1290°F 950°C/1740°F* | |
| 0.5 N.m | M3 | | | | | | | | | |
| 750V | 41A | | | | | | | | | |
| Permanent | 500°C/930°F | | | | | | | | | |
| Peak | 700°C/1290°F 950°C/1740°F* | | | | | | | | | |
| BK063 120 gr. | | BK064 158 gr. | | | | | | | | |
| | | | | | | | | | | |

10mm²

| | | | | | | | | | | |
|----------------------|---|---------------------|-------------|-------------|------------|-----------|-------------|------|-------------------------------|----------------------|
| BK101 50 gr. | SOLID CONDUCTOR 6.5-9.5mm 10mm ² / 6mm ² / 4mm ² AWG8 / AWG10 / AWG12 STRANDED CONDUCTOR 6.5-9.5mm 6mm ² / 4mm ² AWG10 / AWG12 | BK102 90 gr. | | | | | | | | |
| BK103 130 gr. | <table border="1"> <tr> <td>0.8 N.m</td> <td>M3.5</td> </tr> <tr> <td>750V</td> <td>57A</td> </tr> <tr> <td>Permanent</td> <td>500°C/930°F</td> </tr> <tr> <td>Peak</td> <td>700°C/1290°F 950°C/1740°F*</td> </tr> </table> | 0.8 N.m | M3.5 | 750V | 57A | Permanent | 500°C/930°F | Peak | 700°C/1290°F 950°C/1740°F* | BK104 170 gr. |
| 0.8 N.m | M3.5 | | | | | | | | | |
| 750V | 57A | | | | | | | | | |
| Permanent | 500°C/930°F | | | | | | | | | |
| Peak | 700°C/1290°F 950°C/1740°F* | | | | | | | | | |
| | | | | | | | | | | |
| | | | | | | | | | | |

* : Fire conditions, product must be replaced after it.

Because of permanent improvement of our products, drawings, descriptions, features used on these data sheets are for guidance only and can be modified without prior advice

Very high temperature steatite connection blocks, 750V range



Because of permanent improvement of our products, drawings, descriptions, features used on these data sheets are for guidance only and can be modified without prior advice



Not protected against accidental electric contact, nickel terminals, stainless steel screws, nickel pressure plate

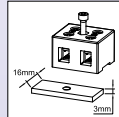
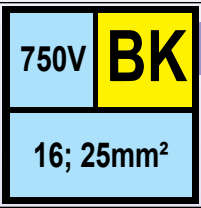
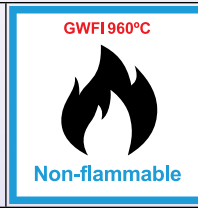
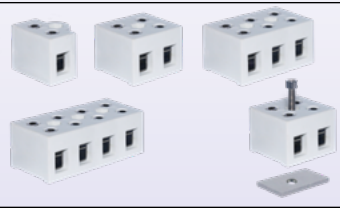
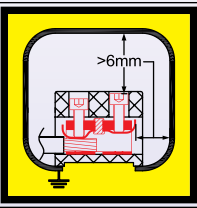
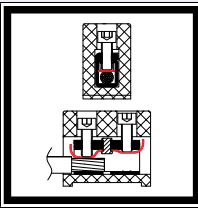

16mm²
Mounting on 16x3mm rail is possible

| | | | | |
|--------------|---------|--|--------------|---------|
| BK161 | 67 gr. | SOLID CONDUCTOR 8-12.5 mm 16mm ² /10mm ² /6mm ² AWG6, AWG8, AWG10 | BK162 | 121 gr. |
| | | STRANDED CONDUCTOR 8-12.5 mm 10mm ² /6mm ² AWG8, AWG10 | | |
| BK163 | 177 gr. | 1.2 N.m 750V Permanent 500°C/930°F Peak 700°C/1290°F 950°C/1740°F* | BK164 | 233 gr. |
| | | M4 79A | | |

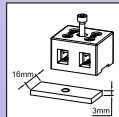

25mm²
Mounting on 16x3mm rail is possible

| | | | | |
|--------------|---------|--|--------------|---------|
| BK251 | 76 gr. | SOLID CONDUCTOR 8.5-12.5 mm 25mm ² / 16mm ² / 10mm ² AWG4 / AWG6 / AWG8 | BK252 | 134 gr. |
| | | STRANDED CONDUCTOR 8.5-12.5 mm 16mm ² / 10mm ² AWG6 / AWG8 | | |
| BK253 | 197 gr. | 2 N.m 750V Permanent 500°C/930°F Peak 700°C/1290°F 950°C/1740°F* | BK254 | 260 gr. |
| | | M5 101A | | |

* : Fire conditions, product must be replaced after it.

Very high temperature steatite connection blocks, 750V range



Not protected against accidental electric contact, nickel terminals, stainless steel screws, nickel pressure plate

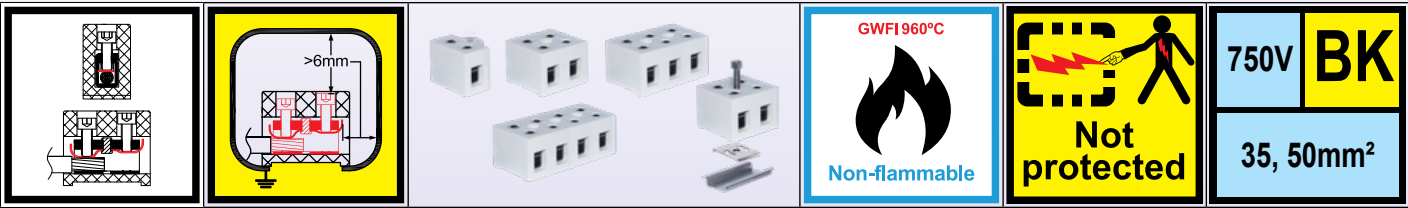

35mm²

Mounting on 35mm Din rail is possible

| | | | | |
|------------------|----------------|--|------------------|----------------|
| BK351 | 136 gr. | SOLID CONDUCTOR 35mm ² / 25mm ² / 16mm ² AWG2 / AWG4 / AWG6 STRANDED CONDUCTOR 25mm ² / 16mm ² AWG4 / AWG6 | BK352 | 242 gr. |
| BK353 | 353 gr. | 2.5 N.m M6 750V 125A Permanent: 500°C/930°F Peak: 700°C/1290°F / 950°C/1740°F* | BK354 | 470 gr. |

50mm²**

Mounting on 35mm Din rail is possible

| | | | | |
|------------------|----------------|--|------------------|----------------|
| BK501 | 165 gr. | SOLID CONDUCTOR 50mm ² / 35mm ² / 25mm ² AWG0 / AWG2 / AWG4 STRANDED CONDUCTOR 35mm ² / 25mm ² AWG2 / AWG4 | BK502 | 317 gr. |
| BK503 | 470 gr. | 3.5 N.m M8 750V 150A** Permanent: 500°C/930°F Peak: 700°C/1290°F / 950°C/1740°F* | BK504 | 630gr. |

* : Fire conditions, product must be replaced after it

** : These cross-section and rating do not exist in EN60998 which is limited to 35mm², so these values are taken from EN60947.

| | | |
|--|-----------------------------|-------------------------|
| | 35mm Din rail mounting clip | Reference 66AT410650 |
|--|-----------------------------|-------------------------|



Very high temperature steatite connection blocks

Indirect pressure clamping, with pressure plate, 750V range

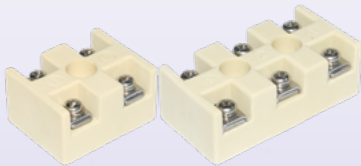
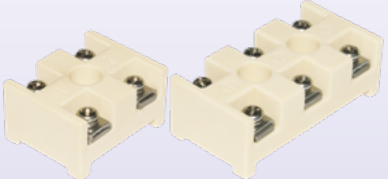

Type BC

Main features

| | | | |
|--|--|--|--|
|  |  |  | <p style="text-align: center;">GWFI 960°C</p>  <p style="text-align: center;">Non-flammable</p> |
| <p>Type BCA (flat backside). Basic model for general applications in electrothermics.</p> | <p>Type BCB (elevated backside) Includes a 4 feet base to allow a remote mounting of the mounting surface and avoid the heat conduction from the support. Suitable for mounting on furnace walls.</p> | <p>Type BCC (with ceramic lid). Includes a ceramic protective cap secured by two M4 screws. It protects against hand contacts, and also prevents short circuits due to the fall of conductive materials in case of fire. Developed for road and railway tunnels for use with fire resistant cables upon IEC60331.</p> | <p style="text-align: center; background-color: #4CAF50; color: white; padding: 5px;">C221 unglazed ceramic</p> |

Applications: These terminal blocks have been developed to meet the specific needs of connections that must withstand very high temperatures, up to **500°C (930°F) permanently and 750°C (1290°F) peak**. They also ensure the continuity of the connection in case of fire up to **900°C (1650°F)** (Their subsequent replacement is then necessary). They are particularly intended for **road tunnels, public transport tunnels (trains, subways), boat and submarine parts that must withstand a fire**, but also for furnace connections when the ambient temperature is permanently very high. Because of their construction, they are non-flammable and resistant to moisture. Although standards IEC (EN) 60998-1 and IEC (EN) 60998-2 have not provided for the special temperature holding conditions of these terminal blocks, their construction meets their specifications (where applicable), for a maximum voltage of **750V**.

At 700°C, in 230V, the leakage current to earth is about 0.1milliampere; The IEC 60331-21 and IEC 60331-11 standards for fire resistance of cables require a maximum leakage current of 2A at 850°C. It is reached only around 900°C in these terminals, for a voltage of 230V. Not protected against accidental electrical contact, they must be installed inside protection boxes.

Typical insulation resistance between two terminals:

- at 100°C (212°F): 1500 MΩ
- at 500°C (900°F): 1000 MΩ
- at 700°C (1290°F): 650 MΩ
- at 900°C (1650°F): 10 MΩ

Dielectric strength: Higher than 6000V at 20°C

Screws: M4x8, 304 stainless steel, with spring washer against loosening at high temperature. Recommended torque 13~20 DaN.cm

Two possible types of screw heads: Phillips or slot upon DIN84

Terminals: 304 Stainless steel

Saddles: 304 Stainless Steel, with or without safety tab against wire shearing

Max wire gauges (per terminal, wires inserted between saddle and connector plate):

- 1 single flexible conductor in 10 mm² (AWG8) or 6mm² (AWG10) whose strands must then be divided into two on either side of the screw.
- One or two flexible conductors in 4mm² (AWG 12), 2.5mm² (AWG14), 1.5mm² (AWG16)
- One or two solid conductors in 6mm² (AWG10), 4mm² (AWG 12), 2.5mm² (AWG14), 1.5mm² (AWG16).

Current carrying capacity: 32A per terminal

Maximum operating voltage: **750V**, in pollution class 3. (Pollution class 3 defines micro environmental conditions causing conductive pollution, or when a non-conductive pollution can become it in case of condensation).

Insulation distances: Greater than **10mm** between mounting face and terminals, between terminals, and **6.4mm** between two connection blocks mounted side by side.

Live parts: Not protected against accidental electrical contact.

Important note: These terminal blocks must imperatively be fixed in order to prevent their movement for any reason in the box in which they are mounted, and consequently put them in a position where the insulation distances are no longer respected.

Maximum ambient temperature:

- Permanent: 500°C (900°F)
- In peak short duration: 700°C (1292°F)
- Fire: 900°C (1650°F) for two hours (Afterwards equipment must be replaced, but it retains its main characteristics during the fire)

The temperature resistance values of the stainless-steel terminals were validated by wire pull tests according to EN 60998, performed after 48H at 500°C (930°F) and 90 minutes at 700°C (1290°F).

Partially applicable standards: (IEC) EN 60998-1; (IEC) EN 60998-2-1

Caution: Special care must be taken to avoid electric shock. These terminal blocks are not usable in places accessible without tools. They must be mounted in protective boxes. Respect the distances in the air of at least **6mm** between the parts under tension and the walls of the protective case. Other rules may apply according to local safety regulations.

Options: These terminal blocks can be made with brass or nickel terminals and saddles (MOQ apply and references on request). In these two configurations, the maximum permissible intensity per terminal rises from 37A to 53A, and the temperature resistance conditions are modified as follows:

| Material | Permanent temperature | Peak Temperature | Fire conditions Temperature |
|----------|-----------------------|------------------|-----------------------------|
| Brass | 230°C (450°F) | 450°C (840°F) | Not resistant |
| Nickel | 500°C (930°F) | 700°C (1290°F) | 120 min at 950°C (1740°F) |

Because of permanent improvement of our products, drawings, descriptions, features used on these data sheets are for guidance only and can be modified without prior advice

Very high temperature steatite connection blocks, 750V range

Terminals and screws in stainless steel.



Not protected against accidental electric contact, indirect pressure clamping by saddle, flat backside.

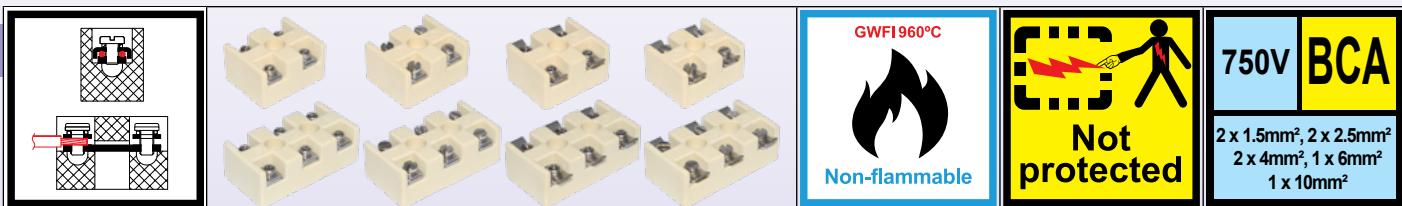

The different terminal models

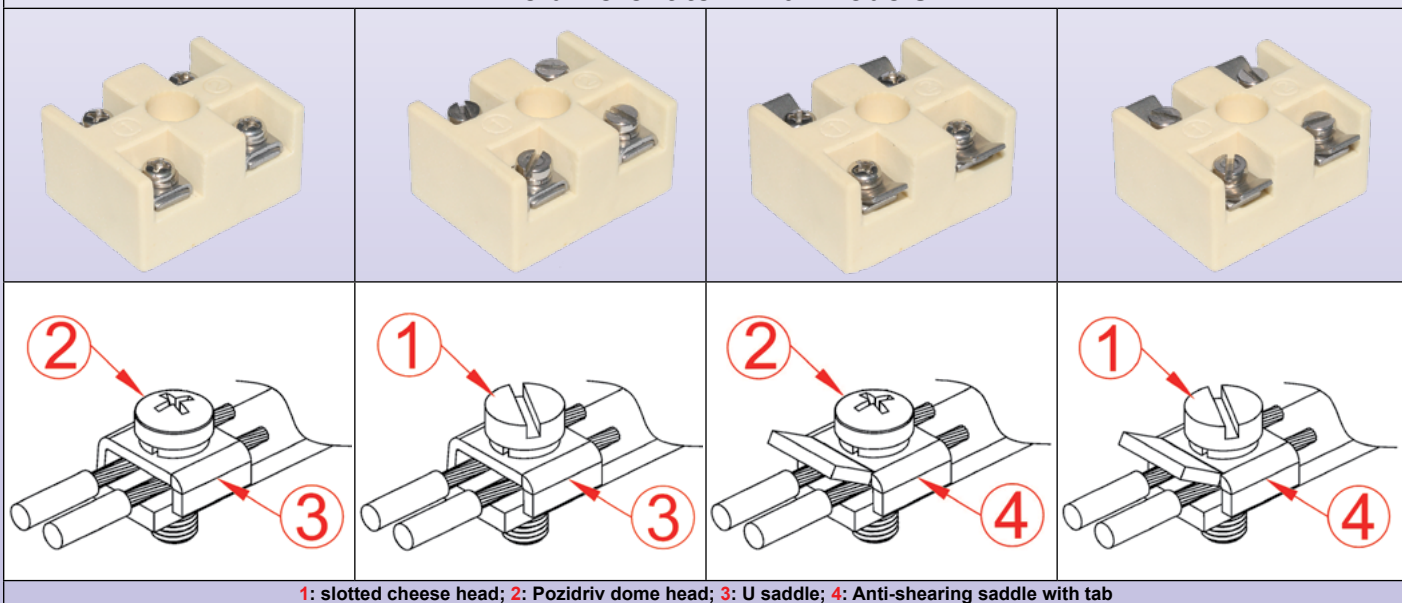

1: slotted cheese head; 2: Pozidriv dome head; 3: U saddle; 4: Anti-shearing saddle with tab

Models with U saddle type 3

| | | |
|--|--|--|
| <p>BCA2C3U0(Screw type 1) 56 gr.</p> <p>3mm, 10mm, 2mm, 8mm, 21mm, 10.5mm, Ø8mm, 4mm, 11mm, 32mm, 10mm, 22mm, 40mm, Ø5mm, 2x4 □r, 1x10 □f, JPCI 750V</p> | <p>SOLID CONDUCTOR</p> <p>1 x 6mm² / 2 x 4mm² / 2 x 2.5mm² / 2 x 1.5mm² 1 x AWG10 / 2 x AWG12 / 2 x AWG14 / 2 x AWG16</p> <p>7-8.5 mm</p> <p>STRANDED CONDUCTOR</p> <p>1 x 10mm² / 1 x 6mm² / 2 x 4mm² / 2 x 2.5mm² / 2 x 1.5mm² 1 x AWG8 / 1 x AWG10 / 2 x AWG12 / 2 x AWG14 / 2 x AWG16</p> <p>7-8.5 mm</p> | <p>BCA3C3U0(Screw type 1) 90 gr.</p> <p>3mm, 10mm(x2), 2mm, 8mm, 21mm, 10.5mm, Ø8mm(x2), 4mm, 22mm, 11mm, 32mm, 10mm, 10mm, 22mm, 22mm, 62mm, Ø5mm(x2), 2x4 □r, 1x10 □f, JPCI 750V</p> |
| <p>BCA2C2U0(Screw type 2) 50 gr.</p> <p>3mm, 10mm, 2mm, 8mm, 21mm, 10.5mm, Ø8mm, 4mm, 11mm, 32mm, 10mm, 22mm, 40mm, Ø5mm, 2x4 □r, 1x10 □f, JPCI 750V</p> | <p>1.2 N.m M4</p> <p>750V 32A*</p> <p>Permanent 500°C/930°F Peak 700°C/1290°F</p> | <p>BCA3C2U0(Screw type 2) 80 gr.</p> <p>3mm, 10mm(x2), 2mm, 8mm, 21mm, 10.5mm, Ø8mm(x2), 4mm, 22mm, 11mm, 32mm, 10mm, 10mm, 22mm, 22mm, 62mm, Ø5mm(x2), 2x4 □r, 1x10 □f, JPCI 750V</p> |

Because of permanent improvement of our products, drawings, descriptions, features used on these data sheets are for guidance only and can be modified without prior advice



Models with anti-shearing saddle type 4

| | | | | | | |
|--|---|--|-------------|------|--------------|--|
| <p>BCA2C3B0(Screw type 1) 56 gr.</p> | <p>SOLID CONDUCTOR</p> <p>1 x 6mm² / 2 x 4mm² / 2 x 2.5mm² / 2 x 1.5mm²</p> <p>1 x AWG10 / 2 x AWG12 / 2 x AWG14 / 2 x AWG16</p> <p>SOLID CONDUCTOR</p> <p>1 x 10mm² / 1 x 6mm² / 2 x 4mm² / 2 x 2.5mm² / 2 x 1.5mm²</p> <p>1 x AWG8 / 1 x AWG10 / 2 x AWG12 / 2 x AWG14 / 2 x AWG16</p> | <p>BCA3C3B0(Screw type 1) 90 gr.</p> | | | | |
| <p>BCA2C2B0(Screw type 2) 50 gr.</p> | <p>1.2 N.m</p> <p>M4</p> <p>750V</p> <p>32A*</p> <table border="1"> <tr> <td>Permanent</td> <td>500°C/930°F</td> </tr> <tr> <td>Peak</td> <td>700°C/1290°F</td> </tr> </table> | Permanent | 500°C/930°F | Peak | 700°C/1290°F | <p>BCA3C2B0(Screw type 2) 80 gr.</p> |
| Permanent | 500°C/930°F | | | | | |
| Peak | 700°C/1290°F | | | | | |

* : Ampacity limited to 32A as a result of the self-heating of the stainless-steel terminal by Joule effect.

Because of permanent improvement of our products, drawings, descriptions, features used on these data sheets are for guidance only and can be modified without prior advice

Very high temperature steatite connection blocks, 750V range

Terminals and screws in stainless steel.



Not protected against accidental electric contact, indirect pressure clamping by saddle, elevated thermal insulating backside.

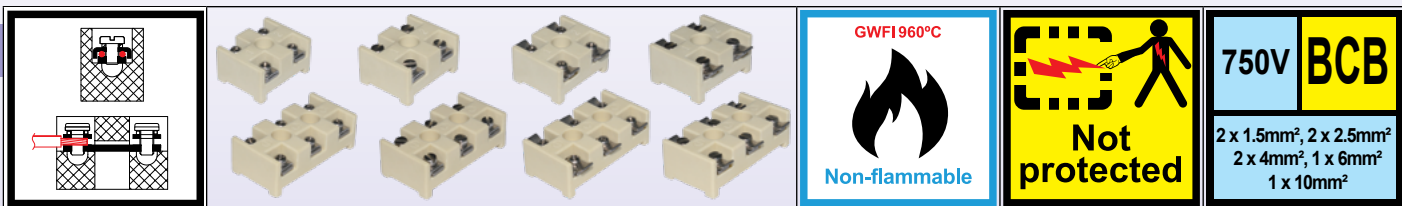

The different terminal models

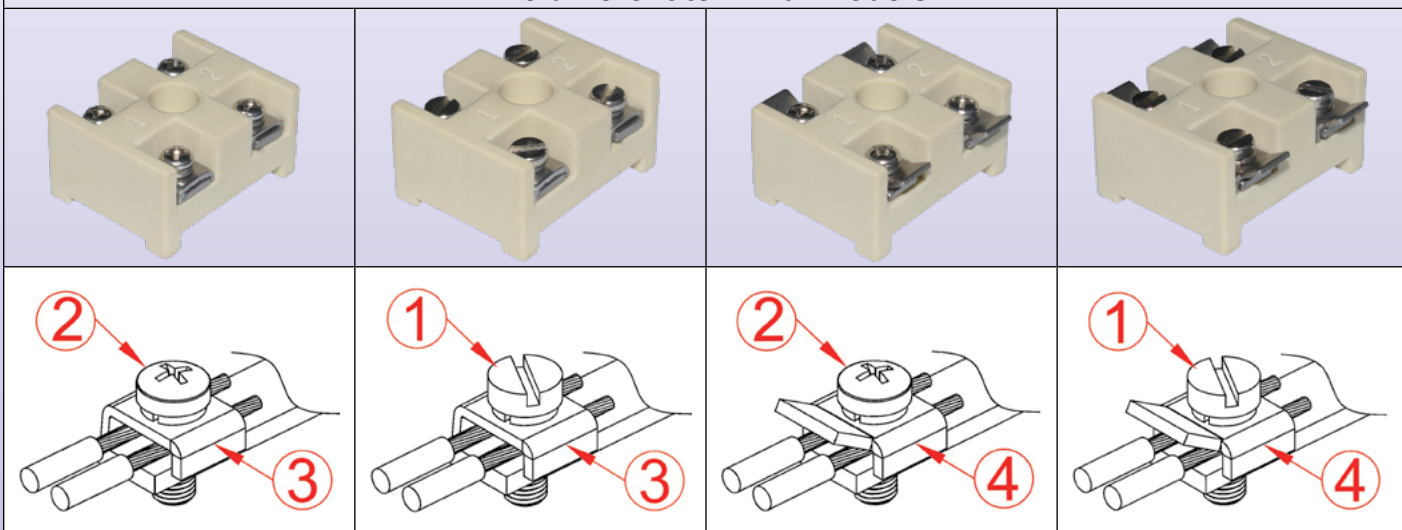

1: slotted cheese head; 2: Pozidriv dome head; 3: simple saddle; 4: Anti-shearing saddle with tab

The 4-foot backside is used to thermally isolate the terminal block when it is mounted on a very hot surface; It also avoids the rotation of the terminal block if it is fixed on a rail with a single screw.

Models with U saddle type 3

| | | |
|---|--|---|
| <p>BCB2C3U0(Screw type 1) 56 gr.</p> <p>3.2mm 10mm 21mm 8mm 10.5mm 31mm 4mm 2mm 11mm 32mm 10mm 40mm 2x4 □Ra 1x10 □f JPCI 750V</p> | <p>SOLID CONDUCTOR</p> <p>1 x 6mm² / 2 x 4mm² / 2 x 2.5mm² / 2 x 1.5mm²</p> <p>1 x AWG10 / 2 x AWG12 / 2 x AWG14 / 2 x AWG16</p> <p>STRANDED CONDUCTOR</p> <p>1 x 10mm² / 1 x 6mm² / 2 x 4mm² / 2 x 2.5mm² / 2 x 1.5mm²</p> <p>1 x AWG8 / 1 x AWG10 / 2 x AWG12 / 2 x AWG14 / 2 x AWG16</p> | <p>BCB3C3U0(Screw type 1) 90 gr.</p> <p>3mm 10mm(x2) 2mm 21mm 10.5mm 53mm 8mm 4mm 2mm 2mm 11mm 32mm 10mm 22mm 22mm 62mm 2x4 □Ra 1x10 □f JPCI 750V</p> |
| <p>BCB2C2U0(Screw type 2) 50 gr.</p> <p>3.2mm 10mm 21mm 8mm 10.5mm 31mm 4mm 2mm 11mm 32mm 10mm 40mm 2x4 □Ra 1x10 □f JPCI 750V</p> | <p>1.2 N.m M4</p> <p>750V 32A*</p> <p>Permanent 500°C/930°F Peak 700°C/1290°F</p> | <p>BCB3C2U0(Screw type 2) 80 gr.</p> <p>3mm 10mm(x2) 2mm 21mm 10.5mm 53mm 8mm 4mm 2mm 2mm 11mm 32mm 10mm 22mm 22mm 62mm 2x4 □Ra 1x10 □f JPCI 750V</p> |

Because of permanent improvement of our products, drawings, descriptions, features used on these data sheets are for guidance only and can be modified without prior advice



Models with anti-shearing saddle type 4

| | | | | | | |
|--|--|--|-------------|------|--------------|--|
| <p>BCB2C3B0(Screw type 1) 56 gr.</p> | <p>SOLID CONDUCTOR</p> <p>1 x 6mm² / 2 x 4mm² / 2 x 2.5mm² / 2 x 1.5mm² 1 x AWG10 / 2 x AWG12 / 2 x AWG14 / 2 x AWG16</p> <p>STRANDED CONDUCTOR</p> <p>1 x 10mm² / 1 x 6mm² / 2 x 4mm² / 2 x 2.5mm² / 2 x 1.5mm² 1 x AWG8 / 1 x AWG10 / 2 x AWG12 / 2 x AWG14 / 2 x AWG16</p> | <p>BCB3C3B0(Screw type 1) 90 gr.</p> | | | | |
| <p>BCB2C2B0(Screw type 2) 50 gr.</p> | <p>1.2 N.m M4</p> <p>750V 32A*</p> <table border="1"> <tr> <td>Permanent</td> <td>500°C/930°F</td> </tr> <tr> <td>Peak</td> <td>700°C/1290°F</td> </tr> </table> | Permanent | 500°C/930°F | Peak | 700°C/1290°F | <p>BCB3C2B0(Screw type 2) 80 gr.</p> |
| Permanent | 500°C/930°F | | | | | |
| Peak | 700°C/1290°F | | | | | |

* : Ampacity limited to 32A as a result of the self-heating of the stainless-steel terminal by Joule effect.

Because of permanent improvement of our products, drawings, descriptions, features used on these data sheets are for guidance only and can be modified without prior advice

Very high temperature steatite connection blocks, 750V range

Terminals and screws in stainless steel.



Protected against accidental electric contact, indirect pressure clamping by saddle, **with steatite protection cover**
SPECIAL MODEL FOR FIRE RESISTANT CABLES

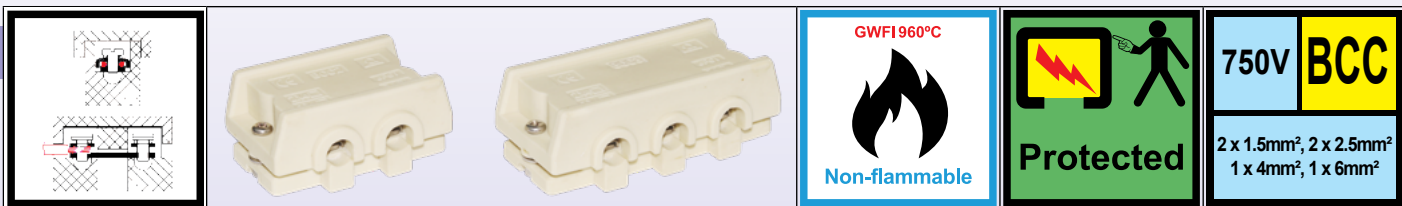

Flexible mineral-insulated cables are designed to provide optimum fire resistance. They generally use mica-based insulation and special silicones, and they are designed to give the ultimate fire performance. Used in power and control circuits, they are providing circuit integrity during a 15 to 180 minutes fire depending of models. They usually have a continuous operating temperature up to 200°C (390°F). They are used in places where it is important to have an interrupted power supply in case of fire. These applications are found in railway stations and underground rail systems, road and rail tunnels, airports, public lighting, car parks, public service buildings, shopping malls, schools, hospitals, hotels, theatres, churches, power distribution and sub circuits, fire alarms and emergency, lifts and escalators lighting. They also have some applications in high temperature situations like foundries, power stations, boiler houses, iron and steel industries, marine and ship buildings, offshore installations.

These terminal blocks provide an economical solution for fire-resistant connection of mineral-insulated flexible cables with an outside diameter of less than 8.5mm and greater than 3.7mm. In sections 1.5mm² and 2.5mm² two cables can be connected to the same terminal. Only one can be connected in 4mm² and 6mm²

- They don't require special termination of the cable, but simply the stripping of the conductor on 8 to 10mm.
- They can be used inside buildings, under pollution conditions 3
- They provide protection against accidental electrical contact.
- They ensure the integrity of the electrical circuit for 3 hours at 950°C (1740°F).
- With and ingress protection class IP31, they are not intended for outdoor connections, or in areas where there is a risk of falling or splashing water or liquids.
- They are not usable in explosive areas.

Their other specs are the same than models BCA.

| BCC2C3U1 | | 65 gr. | SOLID CONDUCTOR | BCC3C3U1 | | 100 gr. | |
|----------|--|--|-----------------|--------------------------|--|--|--|
| | | <p>1 x 6mm² / 2 x 4mm² / 2 x 2.5mm² / 2 x 1.5mm² 1 x AWG10 / 2 x AWG12 / 2 x AWG14 / 2 x AWG 16</p> | | | | <p>1 x 6mm² / 2 x 4mm² / 2 x 2.5mm² / 2 x 1.5mm² 1 x AWG10 / 2 x AWG12 / 2 x AWG14 / 2 x AWG 16</p> | |
| | | <p>1.2 N.m M4</p> | | | | | |
| | | <p>750V</p> | | <p>32A*</p> | | | |
| | | <p>Permanent 500°C/930°F</p> | | <p>Peak 700°C/1290°F</p> | | | |

* : Ampacity limited to 32A as a result of the self-heating of the stainless-steel terminal by Joule effect.

Because of permanent improvement of our products, drawings, descriptions, features used on these data sheets are for guidance only and can be modified without prior advice

Round steatite connection blocks 450V range



Because of permanent improvement of our products, drawings, descriptions, features used on these data sheets are for guidance only and can be modified without prior advice



Not protected against accidental electric contact, brass terminals, nickel plated steel screws.

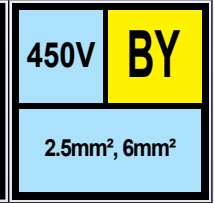
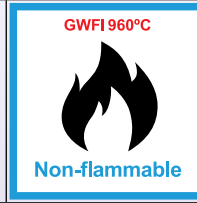
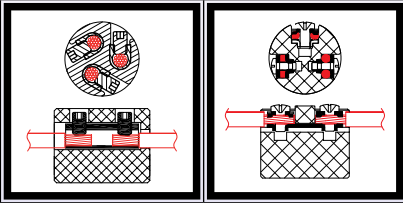

Round terminal blocks. These terminal blocks are intended to be placed in tubes, or to go into round holes during their installation. **Care must be taken to ensure that the terminal screw heads remain permanently at a sufficient distance from the tube if it is metallic. If a minimum clearance of 4mm in air is not achievable, we recommend the installation of an insulating sheath around the terminal block, for example high temperature heat-shrinkable sleeve, or Kapton tape, whose temperature resistance is compatible with the conditions of the installation. This insulation must provide an electric strength of 2500V minimum (More details on EN60698-1§13).**

16.3mm diameter

| | | | | |
|--|--|--|---|--|
| BY1621V33A2 (Was previously BY3Y3) | | 13 gr. | SOLID CONDUCTOR 6mm ² / 4mm ² / 2.5mm ² AWG10 / AWG12 / AWG14 | |
| | | STRANDED CONDUCTOR 4mm ² / 2.5mm ² / 1.5mm ² AWG12 / AWG14 / AWG16 | | |
| | | 0.5 N.m | M3 | |
| | | 450V | 41A | |
| | | Permanent | 230°C/450°F | |
| | | Peak | 450°C/840°F | |

22mm diameter

| | | | | |
|--------------------|--|---|--|--|
| BY2227C33C2 | | 25 gr. | SOLID CONDUCTOR M3: 6-7.5 mm M3.5: 7-8.5 mm 2 x 2.5mm ² / 2 x 1.5mm ² / 2 x 1mm ² 2 x AWG14 / 2x AWG16 / 2 x AWG18 | |
| | | STRANDED CONDUCTOR M3: 6-7.5 mm M3.5: 7-8.5 mm 2 x 2.5mm ² / 2 x 1.5mm ² / 2 x 1mm ² 2 x AWG14 / 2x AWG16 / 2 x AWG18 | | |
| | | M3 : 0.5N.m M3.5 : 0.8N.m | M3 / M3.5 | |
| | | 450V | 24A | |
| | | Permanent | 230°C/450°F | |
| | | Peak | 450°C/840°F | |



25mm diameter

BY2521V55A2

i 26 gr.

SOLID CONDUCTOR

5.5-7.5 mm



6mm² / 4mm² / 2.5mm²
AWG10 / AWG12 /
AWG14

STRANDED CONDUCTOR

5.5-7.5 mm

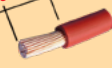

4mm² / 2.5mm² / 1.5mm²
AWG12 / AWG14 /
AWG16



0.5 N.m



M3

450V

41A



Permanent

230°C/450°F

Peak

450°C/840°F

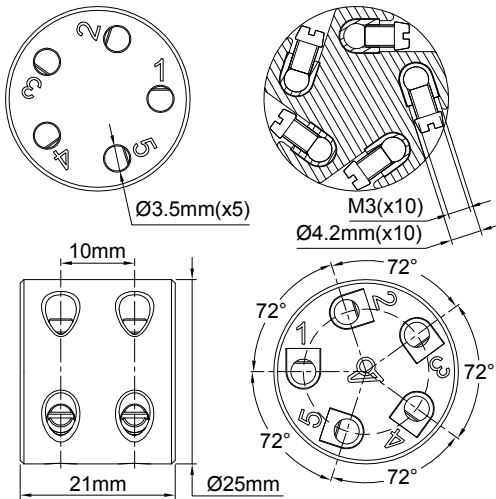

Terminal blocks in ceramic for 3 phase asynchronous electrical motors 450V range



Because of permanent improvement of our products, drawings, descriptions, features used on these data sheets are for guidance only and can be modified without prior advice



Brass or zinc plated steel terminals

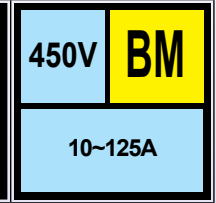
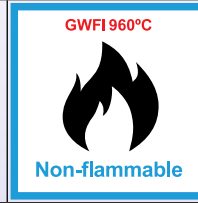
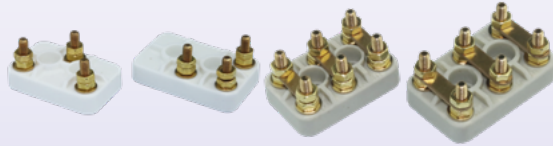
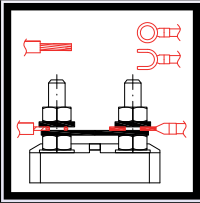

Allows the connection and switching of three-phase star-delta or two separate winding motors, especially for motors with a high operating temperature, particularly in fumes and heat extracting fans. These terminal blocks are also used for the star delta switching of three-phase heaters.

Main features

Material: Steatite C221 (This high-quality ceramic does not require glazing)

Voltage: 450V

Terminals and screws: zinc-plated steel or brass

Shunts: Brass

Insulation distances: > 3mm on backside

Walls of terminal dividers: height 4mm, thickness 5mm

Temperature resistance: 240°C (460°F) continuous, 400°C (750°F) 2 hours peak).

Marking: U1, V1, W1 and U2, V2, W2 (according to IEC 60034-8)

Recommended tightening torques for nuts:

M4: 1.2N.m; M5: 2.5N.m; M6: 3.5N.m; M8: 7N.m

Applicable Standards: IEC 60034-8 and NFC 51-120

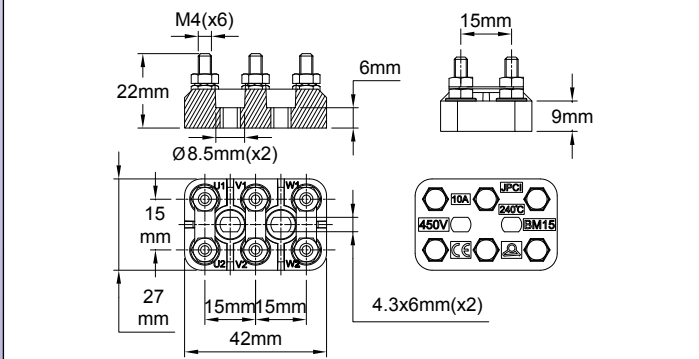

10A 450V models (terminals distance 15mm, M4 screws)

| | With jumper | Without jumpers |
|----------------------------------|-------------|-----------------|
| With brass terminals | BM154B0 | BM154BS |
| With zinc plated steel terminals | BM154S0 | BM154SS |
| Ceramic part only | - | BM14 |

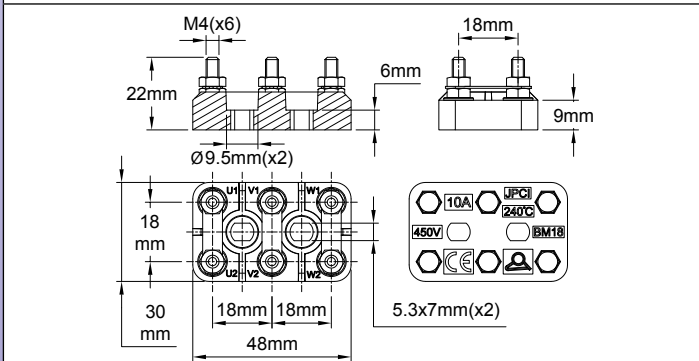

10A 450V models (terminals distance 18mm, M4 screws)

| | With jumper | Without jumpers |
|----------------------------------|-------------|-----------------|
| With brass terminals | BM184B0 | BM184BS |
| With zinc plated steel terminals | BM184S0 | BM184SS |
| Ceramic part only | - | BM184 |

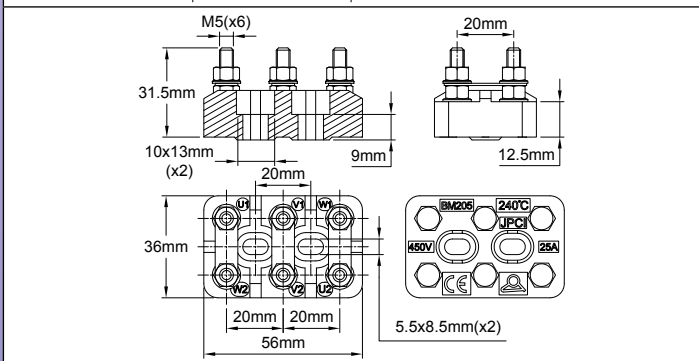

25A 450V model (terminals distance 20mm, M5 screws)

| | With jumper | Without jumpers |
|----------------------------------|-------------|-----------------|
| With brass terminals | BM205B0 | BM205BS |
| With zinc plated steel terminals | BM205S0 | BM205SS |
| Ceramic part only | - | BM205 |

Terminal blocks in ceramic for 3 phase asynchronous electrical motors 450V range



Because of permanent improvement of our products, drawings, descriptions, features used on these data sheets are for guidance only and can be modified without prior advice

| | <p align="center">25A 450V model (terminals distance 23mm, M5 screws)</p> <table border="1"> <thead> <tr> <th></th> <th>With jumper</th> <th>Without jumpers</th> </tr> </thead> <tbody> <tr> <td>With brass terminals</td> <td>BM235B0</td> <td>BM235BS</td> </tr> <tr> <td>With zinc plated steel terminals</td> <td>BM235S0</td> <td>BM235SS</td> </tr> <tr> <td>Ceramic part only</td> <td>-</td> <td>BM235</td> </tr> </tbody> </table> | | With jumper | Without jumpers | With brass terminals | BM235B0 | BM235BS | With zinc plated steel terminals | BM235S0 | BM235SS | Ceramic part only | - | BM235 | | | | | | | | | | | | | | | | | | | | |
|----------------------------------|---|-----------------|-------------|-----------------|----------------------|----------|---------|----------------------------------|------------|---------|----------------------|-----|------------|---------|-------|-----|------------|---------|-------|-----|------------|---------|-----|-----|------------|---------|-----|-----|------------|---------|-------|------|------------|
| | With jumper | Without jumpers | | | | | | | | | | | | | | | | | | | | | | | | | | | | | | | |
| With brass terminals | BM235B0 | BM235BS | | | | | | | | | | | | | | | | | | | | | | | | | | | | | | | |
| With zinc plated steel terminals | BM235S0 | BM235SS | | | | | | | | | | | | | | | | | | | | | | | | | | | | | | | |
| Ceramic part only | - | BM235 | | | | | | | | | | | | | | | | | | | | | | | | | | | | | | | |
| | <p align="center">63A 450V model (terminals distance 25mm, M6 screws)</p> <table border="1"> <thead> <tr> <th></th> <th>With jumper</th> <th>Without jumpers</th> </tr> </thead> <tbody> <tr> <td>With brass terminals</td> <td>BM256B0</td> <td>BM256BS</td> </tr> <tr> <td>With zinc plated steel terminals</td> <td>BM256S0</td> <td>BM256SS</td> </tr> <tr> <td>Ceramic part only</td> <td>-</td> <td>BM256</td> </tr> </tbody> </table> | | With jumper | Without jumpers | With brass terminals | BM256B0 | BM256BS | With zinc plated steel terminals | BM256S0 | BM256SS | Ceramic part only | - | BM256 | | | | | | | | | | | | | | | | | | | | |
| | With jumper | Without jumpers | | | | | | | | | | | | | | | | | | | | | | | | | | | | | | | |
| With brass terminals | BM256B0 | BM256BS | | | | | | | | | | | | | | | | | | | | | | | | | | | | | | | |
| With zinc plated steel terminals | BM256S0 | BM256SS | | | | | | | | | | | | | | | | | | | | | | | | | | | | | | | |
| Ceramic part only | - | BM256 | | | | | | | | | | | | | | | | | | | | | | | | | | | | | | | |
| | <p align="center">63A 450V model (terminals distance 28mm, M6 screws)</p> <table border="1"> <thead> <tr> <th></th> <th>With jumper</th> <th>Without jumpers</th> </tr> </thead> <tbody> <tr> <td>With brass terminals</td> <td>BM286B0</td> <td>BM286BS</td> </tr> <tr> <td>With zinc plated steel terminals</td> <td>BM286S0</td> <td>BM286SS</td> </tr> <tr> <td>Ceramic part only</td> <td>-</td> <td>BM286</td> </tr> </tbody> </table> | | With jumper | Without jumpers | With brass terminals | BM286B0 | BM286BS | With zinc plated steel terminals | BM286S0 | BM286SS | Ceramic part only | - | BM286 | | | | | | | | | | | | | | | | | | | | |
| | With jumper | Without jumpers | | | | | | | | | | | | | | | | | | | | | | | | | | | | | | | |
| With brass terminals | BM286B0 | BM286BS | | | | | | | | | | | | | | | | | | | | | | | | | | | | | | | |
| With zinc plated steel terminals | BM286S0 | BM286SS | | | | | | | | | | | | | | | | | | | | | | | | | | | | | | | |
| Ceramic part only | - | BM286 | | | | | | | | | | | | | | | | | | | | | | | | | | | | | | | |
| | <p align="center">125A 450V model (terminals distance 35mm, M8 screws)</p> <table border="1"> <thead> <tr> <th></th> <th>With jumper</th> <th>Without jumpers</th> </tr> </thead> <tbody> <tr> <td>With brass terminals</td> <td>BM358B0</td> <td>BM358BS</td> </tr> <tr> <td>With zinc plated steel terminals</td> <td>BM358S0</td> <td>BM358SS</td> </tr> <tr> <td>Céramique uniquement</td> <td>-</td> <td>BM358</td> </tr> </tbody> </table> | | With jumper | Without jumpers | With brass terminals | BM358B0 | BM358BS | With zinc plated steel terminals | BM358S0 | BM358SS | Céramique uniquement | - | BM358 | | | | | | | | | | | | | | | | | | | | |
| | With jumper | Without jumpers | | | | | | | | | | | | | | | | | | | | | | | | | | | | | | | |
| With brass terminals | BM358B0 | BM358BS | | | | | | | | | | | | | | | | | | | | | | | | | | | | | | | |
| With zinc plated steel terminals | BM358S0 | BM358SS | | | | | | | | | | | | | | | | | | | | | | | | | | | | | | | |
| Céramique uniquement | - | BM358 | | | | | | | | | | | | | | | | | | | | | | | | | | | | | | | |
| | <p align="center">Brass jumpers for motor terminals blocks</p> <table border="1"> <thead> <tr> <th>Holes distance</th> <th>Thickness</th> <th>Max. Rating</th> <th>Reference</th> </tr> </thead> <tbody> <tr> <td>15~17 mm</td> <td>0.6mm</td> <td>10A</td> <td>66AJB42215</td> </tr> <tr> <td>17~19mm</td> <td>0.8mm</td> <td>10A</td> <td>66AJB42218</td> </tr> <tr> <td>18~22mm</td> <td>0.8mm</td> <td>25A</td> <td>66AJB52220</td> </tr> <tr> <td>21~25mm</td> <td>0.8mm</td> <td>25A</td> <td>66AJB52223</td> </tr> <tr> <td>23~27mm</td> <td>1mm</td> <td>63A</td> <td>66AJB62225</td> </tr> <tr> <td>26~30mm</td> <td>1mm</td> <td>63A</td> <td>66AJB62228</td> </tr> <tr> <td>33~37mm</td> <td>1.5mm</td> <td>125A</td> <td>66AJB82235</td> </tr> </tbody> </table> | Holes distance | Thickness | Max. Rating | Reference | 15~17 mm | 0.6mm | 10A | 66AJB42215 | 17~19mm | 0.8mm | 10A | 66AJB42218 | 18~22mm | 0.8mm | 25A | 66AJB52220 | 21~25mm | 0.8mm | 25A | 66AJB52223 | 23~27mm | 1mm | 63A | 66AJB62225 | 26~30mm | 1mm | 63A | 66AJB62228 | 33~37mm | 1.5mm | 125A | 66AJB82235 |
| Holes distance | Thickness | Max. Rating | Reference | | | | | | | | | | | | | | | | | | | | | | | | | | | | | | |
| 15~17 mm | 0.6mm | 10A | 66AJB42215 | | | | | | | | | | | | | | | | | | | | | | | | | | | | | | |
| 17~19mm | 0.8mm | 10A | 66AJB42218 | | | | | | | | | | | | | | | | | | | | | | | | | | | | | | |
| 18~22mm | 0.8mm | 25A | 66AJB52220 | | | | | | | | | | | | | | | | | | | | | | | | | | | | | | |
| 21~25mm | 0.8mm | 25A | 66AJB52223 | | | | | | | | | | | | | | | | | | | | | | | | | | | | | | |
| 23~27mm | 1mm | 63A | 66AJB62225 | | | | | | | | | | | | | | | | | | | | | | | | | | | | | | |
| 26~30mm | 1mm | 63A | 66AJB62228 | | | | | | | | | | | | | | | | | | | | | | | | | | | | | | |
| 33~37mm | 1.5mm | 125A | 66AJB82235 | | | | | | | | | | | | | | | | | | | | | | | | | | | | | | |

Ceramic cable outlets



Because of permanent improvement of our products, drawings, descriptions, features used on these data sheets are for guidance only and can be modified without prior advice

| | | | | | |
|--------------------------|-----------------------|--------------------------------------|--|--|-----------|
| Halogens FREE | RoHS REACH | C221 unglazed ceramic | | GWFI960°C Non-flammable | BZ |
| | | | | 6 and 10mm | |

Ceramic cable outlet for ovens and kilns and furnaces, allows to pass electrical conductors through a metal wall in areas where the temperature is too high for plastics. The temperature resistance is given by the material of the nut: 230°C with nickel-plated brass nut, 500°C with stainless steel nut.









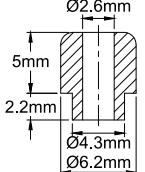

| Diameter | Picture | Drawing | Description | Weight | Reference |
|----------|---------|---------|---|--------|---|
| 10 | | | Ceramic cable outlet for cable up to 6mm diameter Maximum temperature 230°C with nickel plated brass nut, 500°C with stainless steel nut | 5 gr | With nickel plated brass nut: (was previously BEM1021) BZM101206009GE With 304 stainless steel nut: BZM101206009G4 |
| 16 | | | Ceramic cable outlet for cable up to 10mm diameter Maximum temperature 230°C with nickel plated brass nut, 500°C with stainless steel nut. | 10 gr | With nickel plated brass nut: BZM161510009GE With 304 stainless steel nut: BZM161510009G4 |

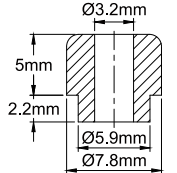
Ceramic insulators for heating elements, 400V range

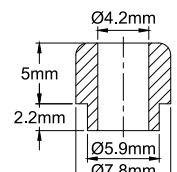

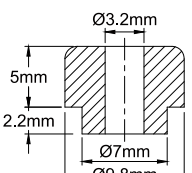
| | | | | | | | | | |
|---|--|--|--|---|--|-------------|-----------|--------------------|--|
|  Halogens FREE |  RoHS REACH |  C610 Alumina |  |  | <table border="1"> <tr> <td style="background-color: #ADD8E6;">400V</td> <td style="background-color: #FFFF00;">BH</td> </tr> <tr> <td colspan="2" style="background-color: #ADD8E6;">6.3 to 11mm</td> </tr> </table> | 400V | BH | 6.3 to 11mm | |
| 400V | BH | | | | | | | | |
| 6.3 to 11mm | | | | | | | | | |

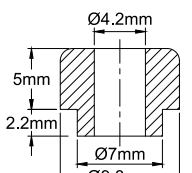
High temperature aluminous ceramic C610, with air clearances and external creepage distances of 5mm, corresponding to **400V insulation in pollution degree 3**. Usable for sheathed tubular heaters of 6.3, 8, 10 and 11mm.

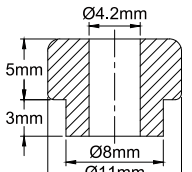
| Picture | Drawing | Heater tube outside diameter | Maximum diameter of connection rod | References |
|---|---|------------------------------|------------------------------------|------------|
|  |  | 6.3mm | 2.5mm | BH43222650 |
|  |  | 8mm | 3mm | BH59223250 |
|  |  | 8mm | 4mm | BH59224250 |
|  |  | 10mm | 3mm | BH70223250 |
|  |  | 10mm | 4mm | BH70224250 |
|  |  | 11mm | 4mm | BH80304250 |

Many other models have been tooled. Consult us with you specs.

Because of permanent improvement of our products, drawings, descriptions, features used on these data sheets are for guidance only and can be modified without prior advice



Because of permanent improvement of our products, drawings, descriptions, features used on these data sheets are for guidance only and can be modified without prior advice

PA 66 connection blocks



Because of permanent improvement of our products, drawings, descriptions, features used on these data sheets are for guidance only and can be modified without prior advice



Types BF and BG, 2.5mm²

Main features

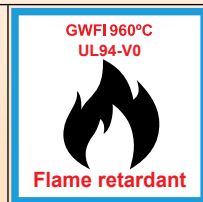
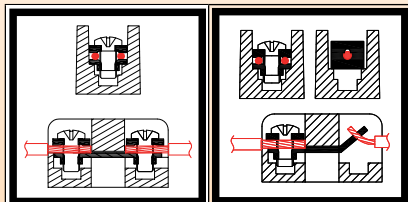

Applications

In electrothermal connection blocks, the requirements are higher than in standard applications: high ambient temperature, frequent thermal cycles, proximity of the ends of the heating elements and their terminals, in a confined space making it difficult for the user to make the wiring.

These terminal blocks have been developed to meet these constraints. However, as they are not protected against accidental electrical contact, **they are intended for internal wiring inside enclosures.**

Main features, identical for all types

Body: Fiberglass-filled Polyamide 66, UL94V0, GWFI (Glow wire flammability index) 960°C, ambient temperature up to 200°C. Heat deflection temperature under 1.8 MPa load according to ISO 75: 226°C. Halogens free.

Terminals: M3 screw terminals, captive with the screw elastic toothed washer, resistant to loosening by vibrations or thermal cycles. These terminals can receive conductors equipped with fork or eyelet wire end terminals but this termination limits the clamping capacity to a single conductor. Cables equipped with cable shoes are limited to 1.5mm² maximum cross-section. The M3 screw can adapt a 4.8mm tab, and jumpers for the interconnection of the terminals are available (see the accessories page)

They are also available with one side equipped with solder terminals and the other with screw terminals. But when terminal blocks have solder terminals, this side can only receive one conductor from 1 to 2.5mm².

Voltage: 400V. The creepage distances between 2 terminals or between live and ground terminals are equal to or greater than 5mm, and clearances in air greater than 3mm (§8.4.2.2 and 8.4.2.3 of EN60947-7-1)

Wire gauge: Unless otherwise specified, each terminal equipped with screw and square washer accepts on each side one or two conductors from 1mm² to 2.5mm². (AWG 18 to AWG14).

Maximum rating per terminal: 24 A, corresponding to a self-heating of the terminal lower than 45°C, required by IEC60947-7§7.2.1.

Other models: similar PA66 terminal blocks for special immersion heater applications have also been developed: see catalog no. 11

Because of permanent improvement of our products, drawings, descriptions, features used on these data sheets are for guidance only and can be modified without prior advice

PA66 connection blocks 400V range, surface mounting



Not protected against accidental electric contact

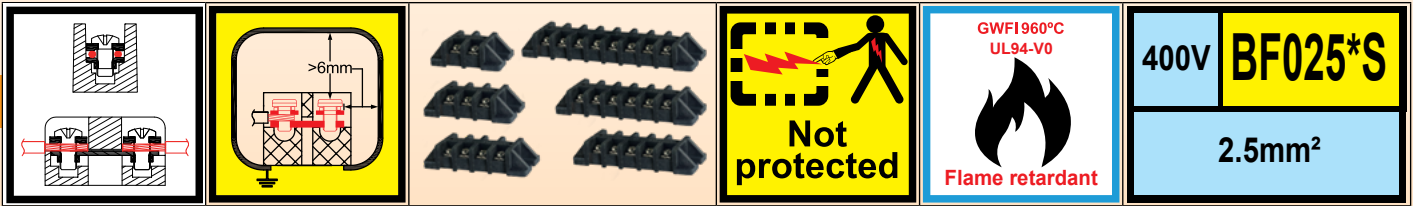

Nickel plated steel screws and square washers on both sides.

| Model | Weight | Terminal Type | Model | Weight |
|-----------------|--------|---|--|--------|
| BF0252SS | 13 gr. | Screw terminal | BF0253SS | 18 gr. |
| | | SOLID CONDUCTOR 2 x 2.5mm² / 2 x 1.5mm² / 2 x 1mm² 2 x AWG14 / 2 x AWG16 / 2 x AWG18 | | |
| | | | STRANDED CONDUCTOR 2 x 2.5mm² / 2 x 1.5mm² / 2 x 1mm² 2 x AWG14 / 2 x AWG16 / 2 x AWG18 | |
| BF0254SS | 24 gr. | | BF0255SS | 28 gr. |
| | | | | |
| BF0256SS | 34 gr. | | BF0258SS | 42 gr. |
| | | 0.5 N.m M3 | | |
| | | 400V 24A | | |
| | | Permanent 180°C/356°F Peak 200°C/392°F | | |

Because of permanent improvement of our products, drawings, descriptions, features used on these data sheets are for guidance only and can be modified without prior advice

PA66 connection blocks 400V range, surface mounting



Not protected against accidental electric contact

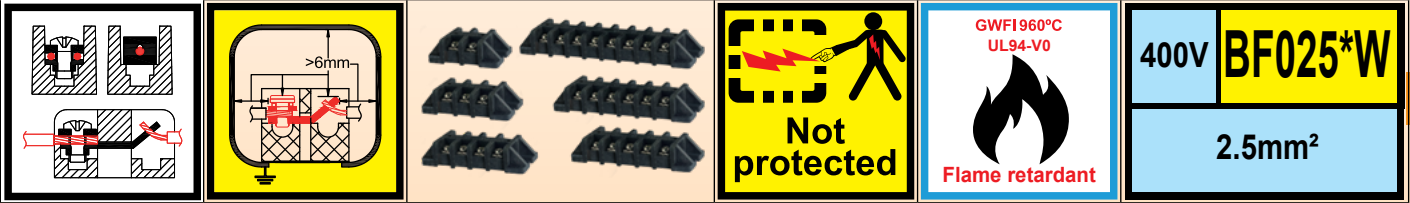

Nickel plated steel screws and square washers on one side, solder terminals on the other side

| | | | | | | | | | | |
|-----------------|-------------|--|---|-----------------|-----------|-------------|------|-------------|--|--|
| BF0252WS | 16 gr. | Screw terminal | BF0253WS | 22 gr. | | | | | | |
| | | SOLID CONDUCTOR 6-7.5 mm 2 x 2.5mm ² / 2 x 1.5mm ² / 2 x AWG14 / 2x AWG16 / 2 x AWG18 | | | | | | | | |
| BF0254WS | | 28 gr. | STRANDED CONDUCTOR 6-7.5 mm 2 x 2.5mm ² / 2 x 1.5mm ² / 2 x AWG14 / 2x AWG16 / 2 x AWG18 | BF0255WS | 34 gr. | | | | | |
| | | 0.5 N.m M3 | | | | | | | | |
| BF0256WS | | 41 gr. | Solder terminal | BF0258WS | 52 gr. | | | | | |
| | | SOLID CONDUCTOR 6-7.5 mm 2.5mm ² / 1.5mm ² / 1mm ² AWG14 / AWG16 / AWG18 | | | | | | | | |
| | | STRANDED CONDUCTOR 6-7.5 mm 2.5mm ² / 1.5mm ² / 1mm ² AWG14 / AWG16 / AWG18 | | | | | | | | |
| | | <table border="1"> <tr> <td>400V</td> <td>24A</td> </tr> <tr> <td>Permanent</td> <td>180°C/356°F</td> </tr> <tr> <td>Peak</td> <td>200°C/392°F</td> </tr> </table> | 400V | 24A | Permanent | 180°C/356°F | Peak | 200°C/392°F | | |
| 400V | 24A | | | | | | | | | |
| Permanent | 180°C/356°F | | | | | | | | | |
| Peak | 200°C/392°F | | | | | | | | | |

Because of permanent improvement of our products, drawings, descriptions, features used on these data sheets are for guidance only and can be modified without prior advice

PA66 connection blocks 400V range, elevated mounting



Not protected against accidental electric contact

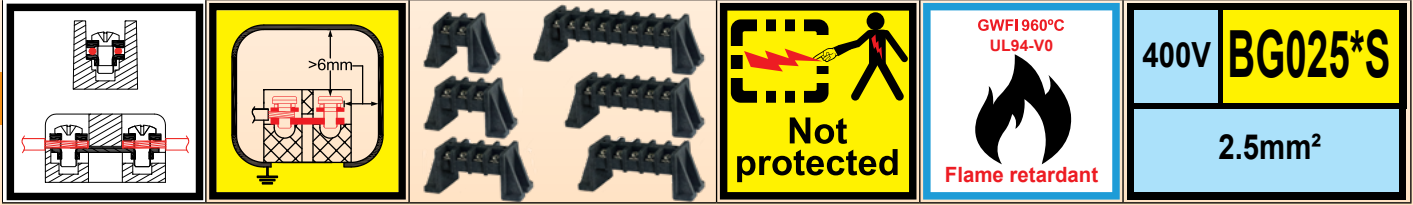

Nickel plated steel screws and square washers on both sides

| BG0252SS | 17 gr. | Screw terminal | BG0253SS | 22 gr. |
|----------|--------|--|---|--------|
| | | <p>SOLID CONDUCTOR</p> <p>2 x 2.5mm² / 2 x 1.5mm² / 2 x 1mm² 2 x AWG14 / 2 x AWG16 / 2 x AWG18</p> | | |
| | 28 gr. | | <p>STRANDED CONDUCTOR</p> <p>2 x 2.5mm² / 2 x 1.5mm² / 2 x 1mm² 2 x AWG14 / 2 x AWG16 / 2 x AWG18</p> | |
| | 38 gr. | <p>0.5 N.m M3</p> <p>400V 24A</p> <p>Permanent 180°C/356°F Peak 200°C/392°F</p> | | |
| | | | | |

Because of permanent improvement of our products, drawings, descriptions, features used on these data sheets are for guidance without prior advice

PA66 connection blocks 400V range, elevated mounting



Because of permanent improvement of our products, drawings, descriptions, features used on these data sheets are for guidance only and can be modified without prior advice



Not protected against accidental electric contact

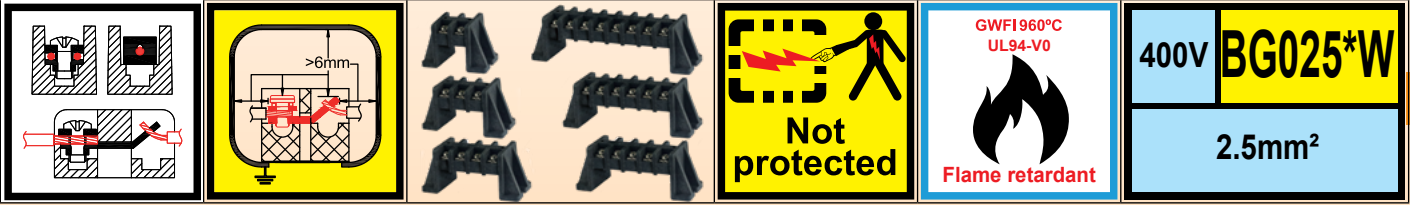

Nickel plated steel screws and square washers on one side, solder terminals on the other side

| | | | | | | | | | | |
|-----------------|-------------|---|-----------------|------------|-----------|-------------|------|-------------|--|--|
| BG0252WS | 20 gr. | Screw terminal | BG0253WS | 26 gr. | | | | | | |
| | | SOLID CONDUCTOR 2 x 2.5mm ² / 2 x 1.5mm ² / 2 x 1mm ² 2 x AWG14 / 2x AWG16 / 2 x AWG18 6-7.5 mm | | | | | | | | |
| BG0254WS | 32 gr. | | BG0255WS | 38 gr. | | | | | | |
| | | <p>0.5 N.m</p> <p>M3</p> | | | | | | | | |
| BG0256WS | 45 gr. | | BG0258WS | 56 gr. | | | | | | |
| | | <p>6-7.5 mm</p> <p>2.5mm² / 1.5mm² / 1mm² AWG14 / AWG16 / AWG18</p> <p>STRANDED CONDUCTOR</p> <p>6-7.5 mm</p> <p>2.5mm² / 1.5mm² / 1mm² AWG14 / AWG16 / AWG18</p> <table border="1"> <tr> <td>400V</td> <td>24A</td> </tr> <tr> <td>Permanent</td> <td>180°C/356°F</td> </tr> <tr> <td>Peak</td> <td>200°C/392°F</td> </tr> </table> | 400V | 24A | Permanent | 180°C/356°F | Peak | 200°C/392°F | | |
| 400V | 24A | | | | | | | | | |
| Permanent | 180°C/356°F | | | | | | | | | |
| Peak | 200°C/392°F | | | | | | | | | |

Tabs, terminals, jumpers for connection blocks

Tabs 4.8mm x 0.8mm with 3.1mm hole. These tabs can be mounted on the screw terminals of the BE series terminal blocks with 2.5mm² cross-section.

| | | <p>4.8 x 0.8 flat tabs, can be mounted on all terminals with M3 screws.</p> <table border="1"> <thead> <tr> <th>Material</th> <th>References</th> </tr> </thead> <tbody> <tr> <td>Un-plated brass</td> <td>66ABB0831169040B</td> </tr> <tr> <td>Nickel plated brass</td> <td>66ABC0831169040B</td> </tr> <tr> <td>Nickel plated steel</td> <td>66ABS0831169040B</td> </tr> </tbody> </table> | Material | References | Un-plated brass | 66ABB0831169040B | Nickel plated brass | 66ABC0831169040B | Nickel plated steel | 66ABS0831169040B |
|--|--------------------|---|----------|------------|---------------------|--------------------|---------------------|--------------------|---------------------|------------------|
| Material | References | | | | | | | | | |
| Un-plated brass | 66ABB0831169040B | | | | | | | | | |
| Nickel plated brass | 66ABC0831169040B | | | | | | | | | |
| Nickel plated steel | 66ABS0831169040B | | | | | | | | | |
| | | <p>64.8 x 0.8 tabs, bent 135°, can be mounted on all terminals with M3 screws.</p> <table border="1"> <thead> <tr> <th>Material</th> <th>References</th> </tr> </thead> <tbody> <tr> <td>Un-plated brass</td> <td>66ADB0841169040C</td> </tr> <tr> <td>Nickel plated brass</td> <td>66ADC0831169040C</td> </tr> <tr> <td>Nickel plated steel</td> <td>66ADS0831169040C</td> </tr> </tbody> </table> | Material | References | Un-plated brass | 66ADB0841169040C | Nickel plated brass | 66ADC0831169040C | Nickel plated steel | 66ADS0831169040C |
| Material | References | | | | | | | | | |
| Un-plated brass | 66ADB0841169040C | | | | | | | | | |
| Nickel plated brass | 66ADC0831169040C | | | | | | | | | |
| Nickel plated steel | 66ADS0831169040C | | | | | | | | | |
| | | <p>4.8 x 0.8 tabs, bent at 90° can be mounted on all terminals with M3 screws.</p> <table border="1"> <thead> <tr> <th>Material</th> <th>References</th> </tr> </thead> <tbody> <tr> <td>Un-plated brass</td> <td>66ACB0831169040D</td> </tr> <tr> <td>Nickel plated brass</td> <td>66ACC0831169040D</td> </tr> <tr> <td>Nickel plated steel</td> <td>66ACS0831169040D</td> </tr> </tbody> </table> | Material | References | Un-plated brass | 66ACB0831169040D | Nickel plated brass | 66ACC0831169040D | Nickel plated steel | 66ACS0831169040D |
| Material | References | | | | | | | | | |
| Un-plated brass | 66ACB0831169040D | | | | | | | | | |
| Nickel plated brass | 66ACC0831169040D | | | | | | | | | |
| Nickel plated steel | 66ACS0831169040D | | | | | | | | | |
| | | <p>4 x 4.75 QC tab terminals, bent at 90°. Having a hole of 3.1 and a hole of 4.1, they can therefore be mounted on PA66 series BE 2.5mm² terminal blocks and BCA and BCB series ceramic terminal blocks. Attention the use of this accessory can reduce the insulation distances of the terminal blocks.</p> <table border="1"> <thead> <tr> <th>Material</th> <th>References</th> </tr> </thead> <tbody> <tr> <td>Un-plated brass</td> <td>66ACB08CE470142D</td> </tr> <tr> <td>Nickel plated brass</td> <td>66ACC08CE470142D</td> </tr> <tr> <td>Nickel plated steel</td> <td>66ACS08CE470142D</td> </tr> </tbody> </table> | Material | References | Un-plated brass | 66ACB08CE470142D | Nickel plated brass | 66ACC08CE470142D | Nickel plated steel | 66ACS08CE470142D |
| Material | References | | | | | | | | | |
| Un-plated brass | 66ACB08CE470142D | | | | | | | | | |
| Nickel plated brass | 66ACC08CE470142D | | | | | | | | | |
| Nickel plated steel | 66ACS08CE470142D | | | | | | | | | |
| <p>6.35 tabs with 4,1mm hole. They are used as replacements for the saddle on ceramic terminal blocks of the BCA and BCB series. They are not compatible with the BCC series. They retain the ability to tighten a conductor under the tab.</p> | | | | | | | | | | |
| | | <p>6.35 tabs with 4.1 hole, flat. Material: 304 stainless steel, or nickel plated steel.</p> <table border="1"> <thead> <tr> <th>Material</th> <th>References</th> </tr> </thead> <tbody> <tr> <td>304 stainless steel</td> <td>66AE40841197006B</td> </tr> <tr> <td>Nickel plated steel</td> <td>66AES0841197006B</td> </tr> </tbody> </table> | Material | References | 304 stainless steel | 66AE40841197006B | Nickel plated steel | 66AES0841197006B | | |
| Material | References | | | | | | | | | |
| 304 stainless steel | 66AE40841197006B | | | | | | | | | |
| Nickel plated steel | 66AES0841197006B | | | | | | | | | |
| | | <p>6.35 tabs with 4.1 hole, bent at 135°. Material: 304 stainless steel, or nickel plated steel.</p> <table border="1"> <thead> <tr> <th>Material</th> <th>References</th> </tr> </thead> <tbody> <tr> <td>304 stainless steel</td> <td>66AG4084116397006C</td> </tr> <tr> <td>Nickel plated steel</td> <td>66AGS084116397006C</td> </tr> </tbody> </table> | Material | References | 304 stainless steel | 66AG4084116397006C | Nickel plated steel | 66AGS084116397006C | | |
| Material | References | | | | | | | | | |
| 304 stainless steel | 66AG4084116397006C | | | | | | | | | |
| Nickel plated steel | 66AGS084116397006C | | | | | | | | | |
| | | <p>6.35 tabs with 4.1 hole, bent at 90°. Material: 304 stainless steel, or nickel plated steel.</p> <table border="1"> <thead> <tr> <th>Material</th> <th>References</th> </tr> </thead> <tbody> <tr> <td>304 stainless steel</td> <td>66AF40841197006D</td> </tr> <tr> <td>Nickel plated steel</td> <td>66AFS0841197006D</td> </tr> </tbody> </table> | Material | References | 304 stainless steel | 66AF40841197006D | Nickel plated steel | 66AFS0841197006D | | |
| Material | References | | | | | | | | | |
| 304 stainless steel | 66AF40841197006D | | | | | | | | | |
| Nickel plated steel | 66AFS0841197006D | | | | | | | | | |



Because of permanent improvement of our products, drawings, descriptions, features used on these data sheets are for guidance only and can be modified without prior advice

Saddles for M4 screw terminals

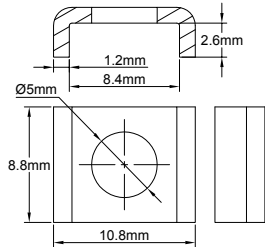
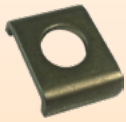

Saddle for M4 screws, 5mm hole, to be mounted on BCA, BCB and BCC series ceramic terminal blocks.

| Material | References |
|---------------------|------------------|
| 304 stainless steel | 66AS412501A1014A |

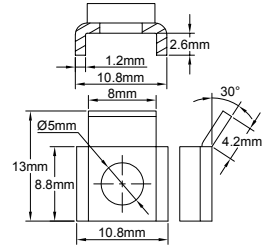

Jumper for M4 screws with anti-shear protection, 5mm hole, to be mounted on terminals of ceramic terminal blocks BCA, BCB series; Incompatible with BCC series.

| Material | References |
|---------------------|------------------|
| 304 stainless steel | 66AR412501A1024A |

Jumpers. They allow to easily connect 2 or 3 adjacent terminals

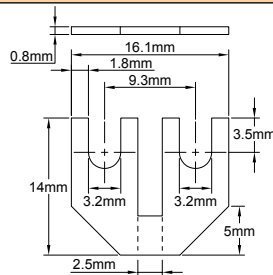

Two ways, 9.3 mm pitch, compatible with the BE 2.5mm² series.

| Material | References |
|-----------------|------------------|
| Un-plated brass | 66AJB0832293041B |

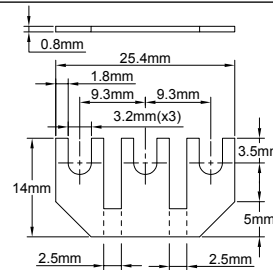
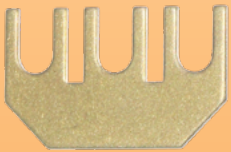

3 ways, 9.3 mm pitch, compatible with the BE 2.5mm² series.

| Material | References |
|-----------------|------------------|
| Un-plated brass | 66AJB0832393042B |

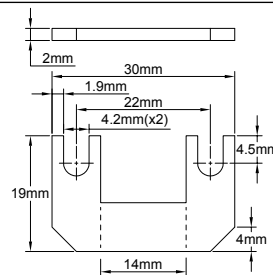
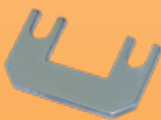

Two ways, 20 mm pitch, compatible with the BCA and BCB series.

| Material | References |
|---------------------|------------------|
| 304 stainless steel | 66AJ420422B0043B |

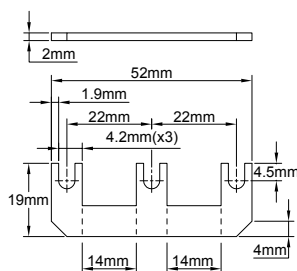
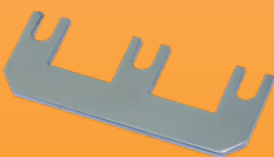

3 ways, 20 mm pitch, compatible with the BCA and BCB series.

| Material | References |
|---------------------|------------------|
| 304 stainless steel | 66AJ420423B0044B |



Because of permanent improvement of our products, drawings, descriptions, features used on these data sheets are for guidance only and can be modified without prior advice



ULTIMHEAT

HEAT & CONTROLS



Catalogues collection on
www.ultimheat.com

Electromechanical components & OEM heating sub-assemblies manufacturer

- Mechanical thermostats
- Mechanical safeties single & three poles
- ATEX thermostats & safeties
- Flow through liquid heaters
- Immersion heaters
- Heating elements for air and liquid
- Connection blocks
- Housings for corrosive environments
- Flow switches
- Level switches
- Pressure switches and air switches
- Fusible links and fire detection mechanisms
- Tracing equipment
- **Taylor made solutions**

THE EFFECTS OF PRACTICE ON THE PERFORMANCE OF A SKILL